FleetPC 8

In-Vehicle Computing

User's Manual

Version 1.0

| | | | | |
|----------------------------|-----------------------|--------------|-------------------------|------------------|
| Document Name | FleetPC 8 User Manual | | Document No. | UM2013360010 |
| Version | 1.0 | | Date | May. 17, 2013 |
| Reversion History : | | | | |
| Reversion | | Date | Notes | Author(s) |
| From | To | | | |
| 1.0 | | May 17, 2013 | Initial document issued | Stanley Chou |
| | | | | |
| | | | | |

CarTFT.com

User Manual

Copyright

©2009 by CarTFT.com All Rights Reserved.

No part of this publication may be reproduced, transcribed, stored in a retrieval system, translated into any language, or transmitted in any form or by any means such as electronic, mechanical, magnetic, optical, chemical, photocopy, manual, or otherwise, without prior written permission from CarTFT.com

Other brands and product names used herein are for identification purposes only and may be trademarks of their respective owners.

Disclaimer

CarTFT.com shall not be liable for any incidental or consequential damages resulting from the performance or use of this product.

CarTFT.com makes no representation or warranty regarding the content of this manual. Information in this manual had been carefully checked for accuracy; however, no guarantee is given as to the correctness of the contents. For continuing product improvement, CarTFT.com reserves the right to revise the manual or make changes to the specifications of this product at any time without notice and obligation to any person or entity regarding such change. The information contained in this manual is provided for general use by customers.

This device complies to Part 15 of the FCC Rules. Operation is subject to the following two conditions:

1. This device may not cause harmful interference.
2. This device must withstand any background interference including those that may cause undesired operation.

Safety Information

Read the following precautions before setting up a CarTFT.com Product.

Electrical safety

- To prevent electrical shock hazard, disconnect the power cable from the electrical outlet before relocating the system.
- When adding or removing devices to or from the system, ensure that the power cables for the devices are unplugged before the signal cables are connected. If possible, disconnect all power cables from the existing system before you add a device.
- Before connecting or removing signal cables from the motherboard, ensure that all power cables are unplugged.
- Seek professional assistance before using an adapter or extension cord. These devices could interrupt the grounding circuit.
- Make sure that your power supply is set to the correct voltage in your area. If you are not sure about the voltage of the electrical outlet you are using, contact your local power company.
- If the power supply is broken, do not try to fix it by yourself. Contact a qualified service technician or your retailer.

Operation safety

- Before installing the motherboard and adding devices on it, carefully read all the manuals that came with the package.
- Before using the product, make sure all cables are correctly connected and the power cables are not damaged. If you detect any damage, contact your dealer immediately.
- To avoid short circuits, keep paper clips, screws, and staples away from connectors, slots, sockets and circuitry.
- Avoid dust, humidity, and temperature extremes. Do not place the product in any area where it may become wet.
- Place the product on a stable surface.
- If you encounter technical problems with the product, contact a qualified service technician or your retailer.

CAUTION

Incorrectly replacing the battery may damage this computer. Replace only with the same or its equivalent as recommended by CarTFT.com. Dispose used battery according to the manufacturer's instructions.

Table of contents

page

(1) Introduction

| | |
|---|---|
| 1.1 Model Specifications | 6 |
| 1.2 FleetPC 8 Illustration (Main board, System) | 8 |

(2) Internal connector specification

| | |
|------------------------------------|----|
| 2.1 VGA JST connector | 10 |
| 2.2 USB JST connector | 11 |
| 2.3 USB JST connector | 12 |
| 2.4 GPIO JST connector | 13 |
| 2.5 UART JST connector | 14 |
| 2.6 LED JST connector (LED1) | 15 |
| 2.7 LED JST connector (LED2) | 16 |
| 2.8 COM port JST connector: (COM3) | 17 |
| 2.9 COM port JST connector: (COM4) | 18 |
| 2.10 AUDIO JST connector | 19 |
| 2.11 SATA 7PIN connector: (SATA3) | 20 |
| 2.12 SATA 7PIN connector: (SATA1) | 21 |
| 2.13 SATA 7PIN connector: (SATA2) | 22 |
| 2.14 MINI PCI-E slot: (MINICARD1) | 23 |
| 2.15 MINI PCI-E slot: (MINICARD2) | 25 |
| 2.16 MINI PCI-E slot: (MINICARD3) | 27 |
| 2.17 MINI PCI-E slot: (MINICARD4) | 29 |
| 2.18 POWER IN connector | 30 |
| 2.19 SATA Power connector: (SPWR1) | 32 |
| 2.20 UPS Power connector | 33 |

(3) External connector specification

| | |
|-----------------------------|----|
| 3.1 USB3.0 Type A connector | 34 |
| 3.2 USB3.0 Type A connector | 35 |
| 3.3 RJ45 connector: (LAN1) | 36 |
| 3.4 RJ45 connector: (LAN2) | 37 |
| 3.5 RJ45 connector: (LAN3) | 38 |
| 3.6 RJ45 connector: (LAN4) | 39 |
| 3.7 DB29 connector: (DVI-I) | 40 |
| 3.8 DP connector | 41 |
| 3.9 DB9 connector: (COM1) | 42 |

| | |
|--|----|
| 3.10 DB9 connector: (COM2) | 43 |
| 3.11 PHONE JACK: (MIC IN) | 44 |
| 3.12 PHONE JACK: (LINE OUT) | 45 |
| 3.13 ATX 6PIN connector : (POWER OUT) | 46 |
| (4) System Installation | |
| 4.1 System Introduction | 47 |
| 4.2 Opening Chassis | 48 |
| 4.3 Installing Memory | 49 |
| 4.4 Installing MINI PCIe Expansion Card (PCIe 1, 3G Module only) | 50 |
| 4.5 Installing MINI PCIe Expansion Card (PCIe 2) | 51 |
| 4.6 Installing MINI PCIe Expansion Card (PCIe 3) | 52 |
| 4.7 Installing MINI PCIe Expansion Card (PCIe 4, PCIe only) | 53 |
| 4.8 Installing Internal Antenna Cable | 54 |
| 4.9 Installing SIM Card | 56 |
| 4.10 Installing HDD | 57 |
| 4.11 Installing Battery Module | 59 |
| (5) System Resources | |
| 5.1 Ignition Power Management Quick Guide | 61 |
| 5.2 GPIO & Delay Time Setting | 63 |
| (6) BIOS | |
| 6.1 Super IO Configuration | 67 |
| (7) Packing List | |
| 7.1 Packing List | 68 |



1.1 Model Specification

| System | |
|-------------------|--|
| CPU | Intel Gen 3 Core i7-3517UE 1.7GHz Intel Gen 3 Core i3-3217UE 1.6GHz Intel Gen 3 Celeron Dual Core 1047E 1.4GHz |
| Memory | 1 x DDR3 1066/1333/1600 MHz SO-DIMM up to 8 GB |
| Chipset | QM77 |
| LAN Chipset | Intel I210-AT Gb/s Ethernet Controllers Onboard Support PXE and WOL |
| Audio | Realtek ALC662 HD Codec onboard |
| Watchdog | Watchdog Timer Support, Offer 1 – 255 Step |
| Power Requirement | |
| Power Input | 9V-32V DC Power input |
| Power Protection | Automatics Recovery Short Circuit Protection |
| Power Management | Vehicle Power Ignition for Variety Vehicle |
| Power Off Control | Power off Delay Time Setting by Software |
| Battery | Internal Battery Kit for 10 Mins Operating (Optional) |
| Storage | |
| Type | 2 x 2.5" Drive Bay for SATA Type HDD / SSD, Support RAID 0, 1 1 x SATA DOM |

| Graphics | |
|----------------------|---|
| Graphics | Intel® HD Graphics 4000 DirectX Video Acceleration (DXVA) for Accelerating Video Processing - Full AVC/VC1/MPEG2 HW Decode Supports DirectX 11/10.1/10/9 and OpenGL 3.0 |
| Resolution | Up to 1920 x 1200 |
| Qualification | |
| Certifications | CE, FCC Class A, eMark |
| I/O | |
| Serial Port | 4 x RS-232 (COM1,2 with RS-422/485, RS-485 Support Auto Direction Control) |
| USB Port | 4 x USB 2.0 Ports on Front I/O |
| LAN | 2 x RJ45 Ports for GbE |
| Video Port | 1 x DVI-I, 1 x VGA and 1 x Display Port Output |
| DIO Port | 4 in and 4 out with Relay 12V / 80mA |
| Audio | 1 x Line-out and 1 x MIC-in |
| SIM Card Socket | 2 x SIM Card sockets supported onboard with eject |
| Environment | |
| Operating Temp. | -40°C ~ 70°C (Default CPU 17Watt) |
| Storage Temp. | -40 ~ 80°C |
| Relative Humidity | 0% RH– 95% RH |
| Vibration (random) | 2.5g@5~500 Hz with SSD |
| Vibration Operating | MIL-STD-810F, Method 514.5, Category 20, Ground Vehicle-Highway |
| Truck Storage | MIL-STD-810F, Method 514.5, Category 24, Integrity Test |
| Shock | Operating: MIL-STD-810F, Method 516.5, Procedure I, Trucks and semi-trailers=40G (11ms) with SSD |
| Crash Hazard | MIL-STD-810F, Method 516.5, Procedure V, Ground equipment=100 |
| Mechanical | |
| Construction | Aluminum alloy |
| Mounting | Supports both of wall-mount/VESA-mount |
| Weight | 1.780 kg (bare-bone) |
| Dimensions | 250 x 150 x 55 mm |

1.2 FleetPC 8 Illustration

Main board

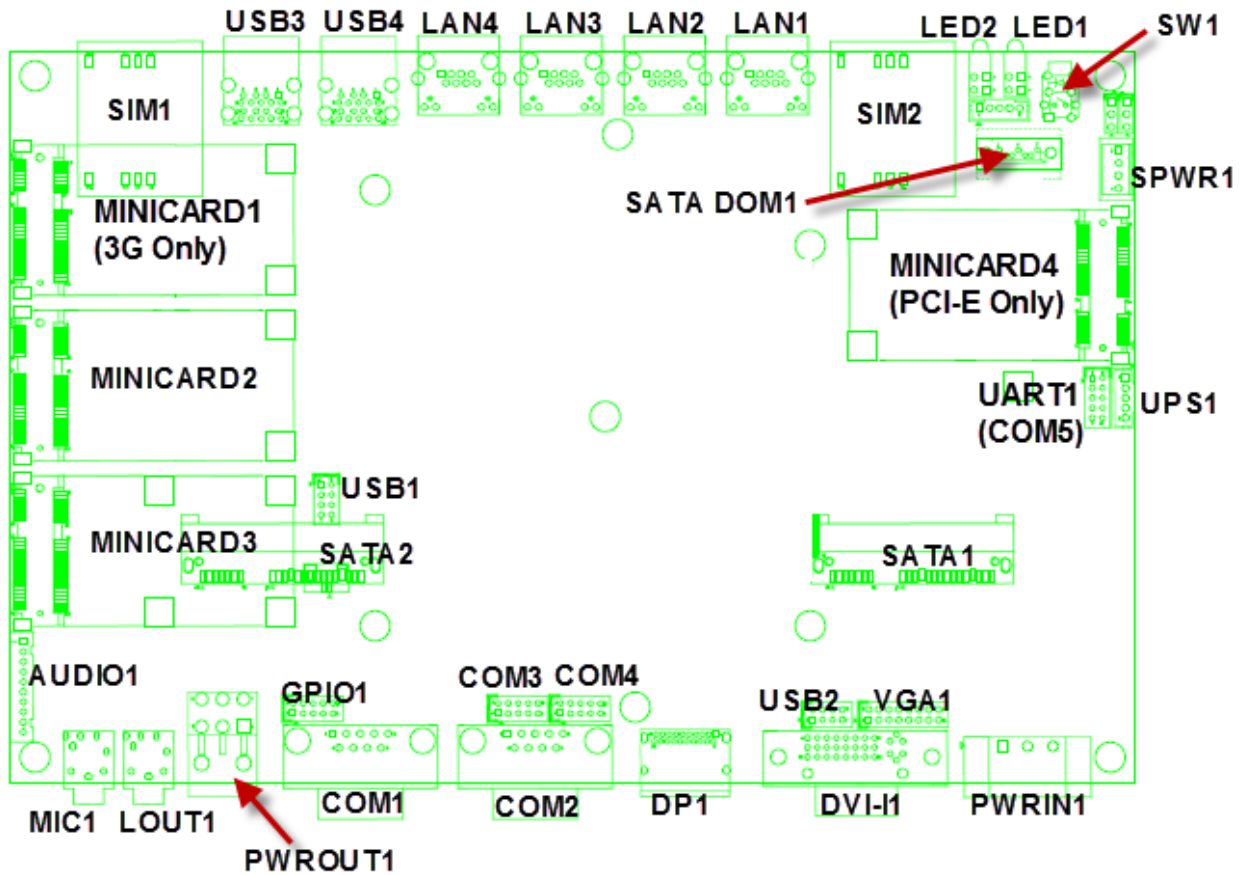

System

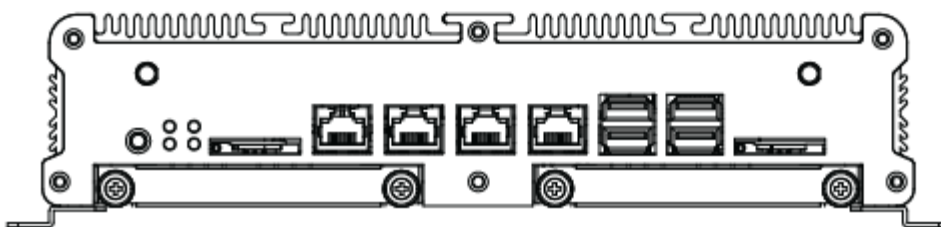
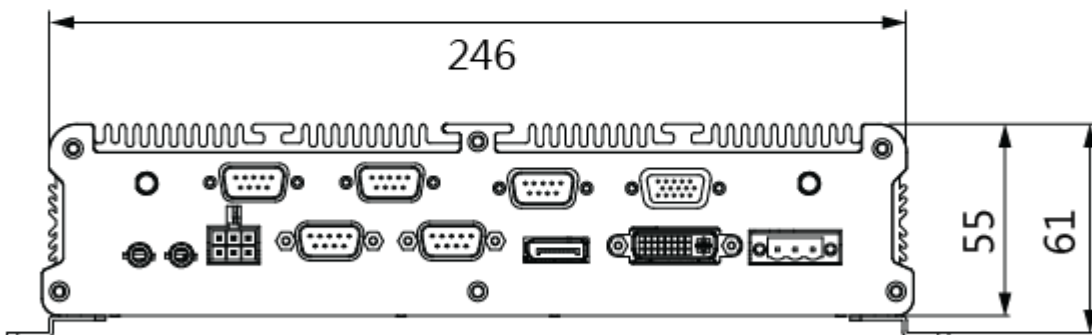
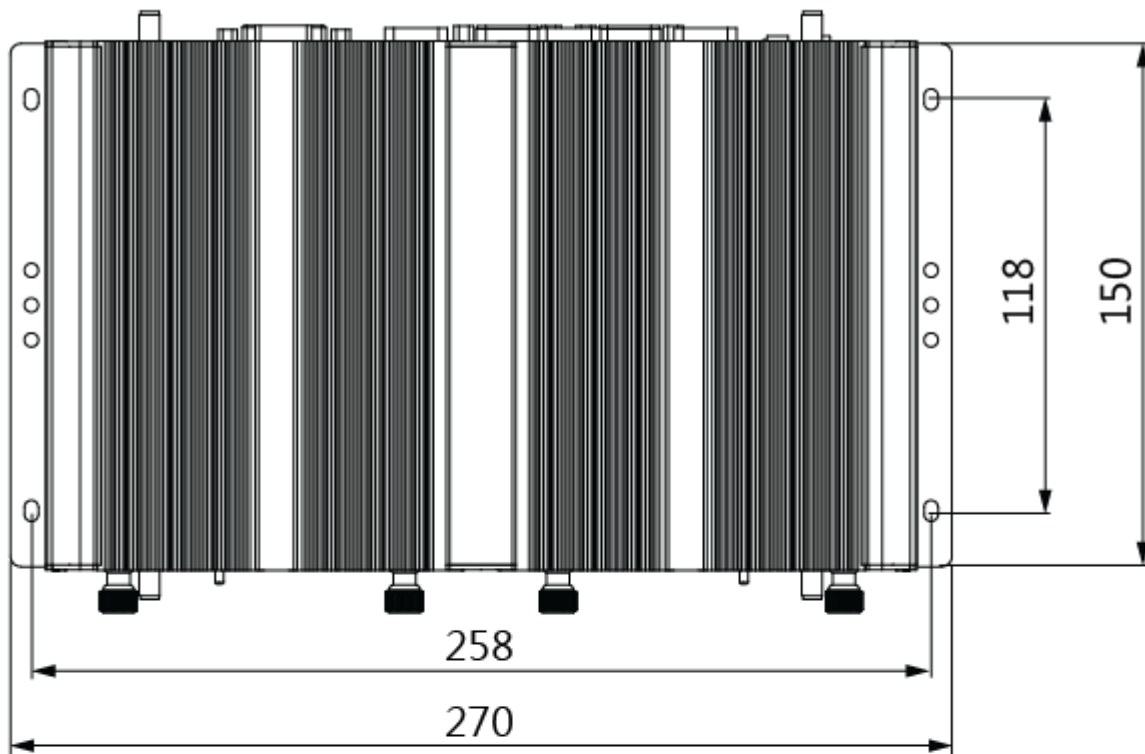

(2) Internal connector specification

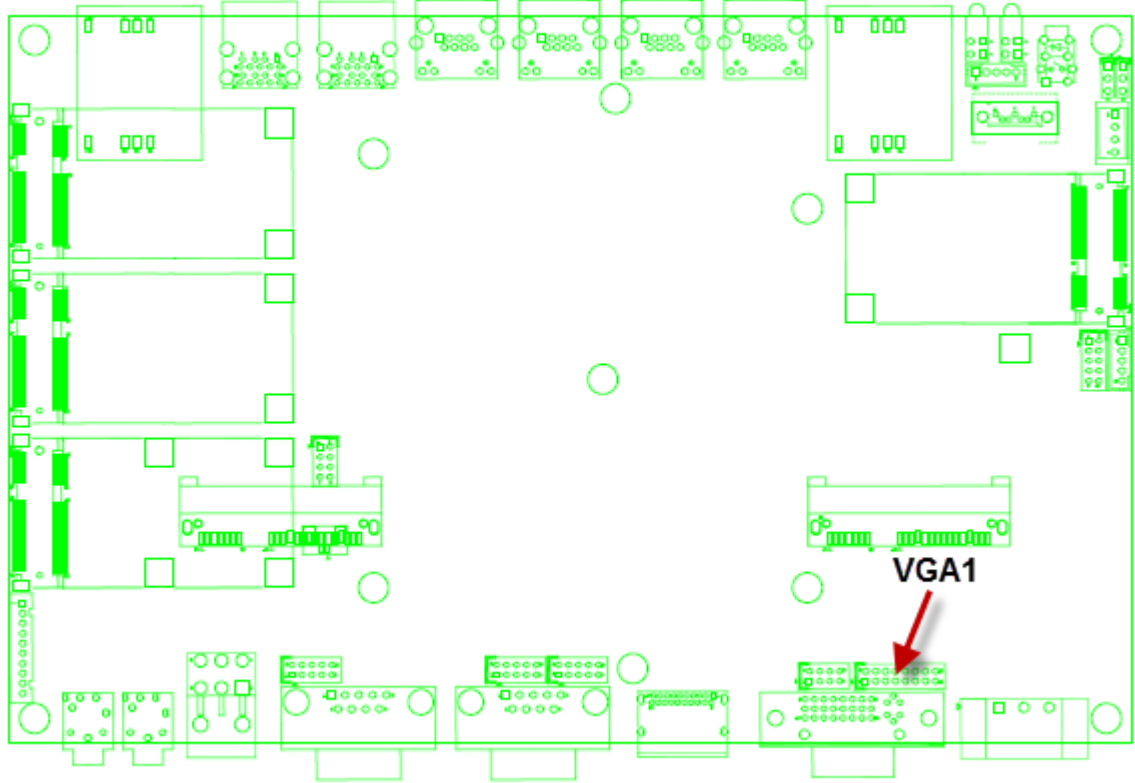
| 2.1 VGA connector | | | | |
|--------------------------|--|---------|-----|---------|
| Connector size | 2 X 8 = 16 Pin | | | |
| Connector type | JST-2.0mm-M-180 | | | |
| Connector location | VGA1 | | | |
| Connector pin definition | Pin | Signal | Pin | Signal |
| | 1 | RED | 2 | GREEN |
| | 3 | BLUE | 4 | NC |
| | 5 | CER_DET | 6 | GND |
| | 7 | GND | 8 | GND |
| | 9 | +5V | 10 | GND |
| | 11 | NC | 12 | DAC_SDA |
| | 13 | HSYNC | 14 | VSYNC |
| | 15 | DAC_SCL | 16 | NC |
| Connector map |  <p>The image shows a green PCB layout with various components. A red arrow points to a connector labeled 'VGA1' located in the lower right quadrant of the board. The connector is a 2x8 pin JST-2.0mm-M-180 type.</p> | | | |

2.2 USB connector

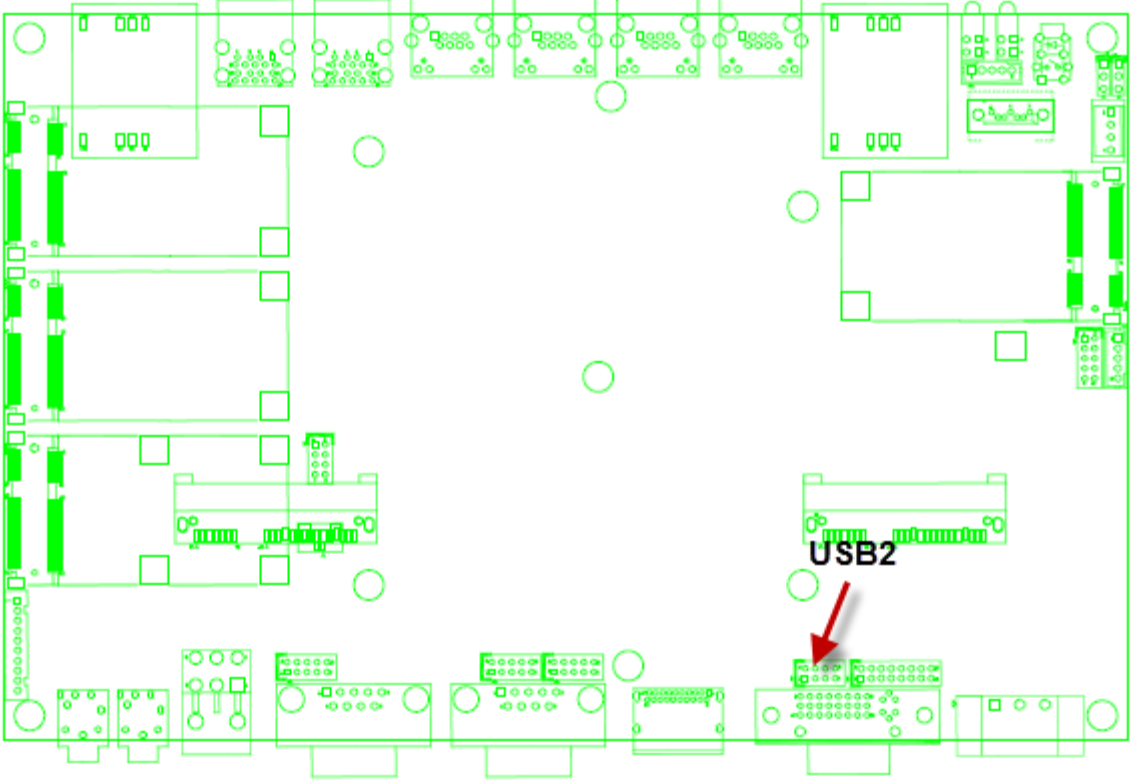
| | | | | | |
|--------------------------|--|--------|-----|--------|--|
| Connector size | 2 X 4 = 8 Pin | | | | |
| Connector type | JST-2.0mm-M-180 | | | | |
| Connector location | USB2 (Co-layout with DVI-I1) | | | | |
| Connector pin definition | Pin | Signal | Pin | Signal | |
| | 1 | 5VSB | 2 | 5VSB | |
| | 3 | USB_7N | 4 | NC | |
| | 5 | USB_7P | 6 | NC | |
| | 7 | GND | 8 | GND | |
| Connector map |  <p>The image shows a green PCB layout with various components. A red arrow points to a specific connector footprint labeled 'USB2' in the lower right quadrant of the board.</p> | | | | |

2.3 USB connector

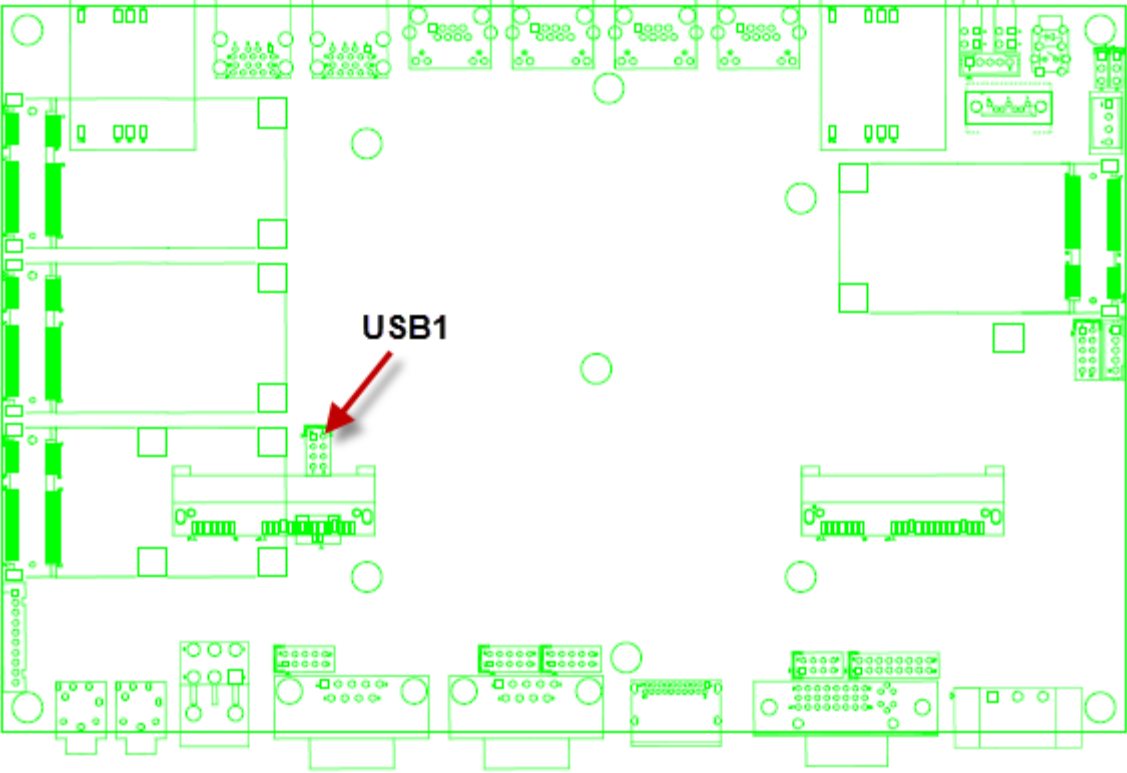
| | | | | | |
|--------------------------|---|--------|-----|--------|--|
| Connector size | 2 X 4 = 8 Pin | | | | |
| Connector type | JST-2.0mm-M-180 | | | | |
| Connector location | USB3 (Co-layout with MINICARD3) | | | | |
| Connector pin definition | Pin | Signal | Pin | Signal | |
| | 1 | 5VSB | 2 | 5VSB | |
| | 3 | USB_6N | 4 | NC | |
| | 5 | USB_6P | 6 | NC | |
| | 7 | GND | 8 | GND | |
| Connector map |  | | | | |

2.4 GPIO connector

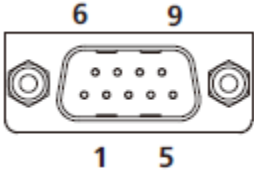
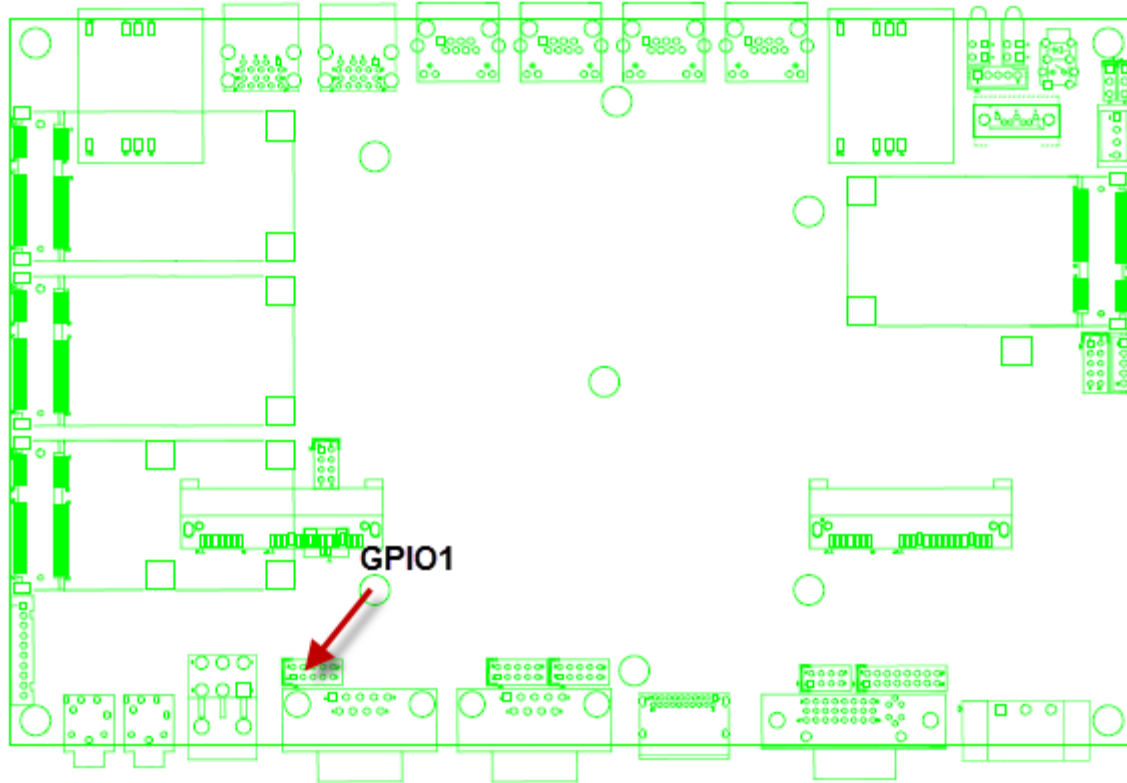
| | | | | |
|--------------------------|---|--------|-----|--------|
| Connector size | 2 X 5 = 10 Pin | | | |
| Connector type | JST-2.0mm-M-180 | | | |
| Connector location | GPIO1  | | | |
| Connector pin definition | Pin | Signal | Pin | Signal |
| | 1 | GPI0 | 2 | GPI1 |
| | 3 | GPI2 | 4 | GPI3 |
| | 5 | GPO0 | 6 | GPO1 |
| | 7 | GPO2 | 8 | GPO3 |
| | 9 | GND | 10 | +12V |
| Connector map |  | | | |

2.5 UART connector

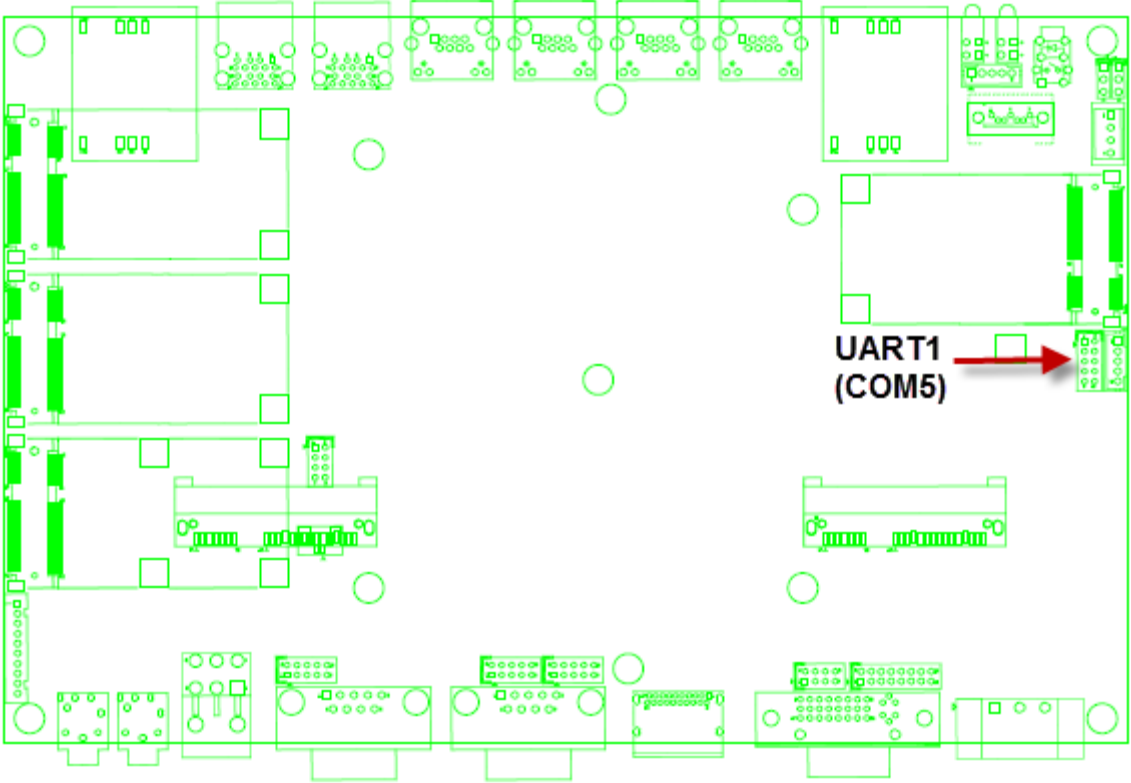
| | | | | | |
|--------------------------|--|---------|-----|---------|--|
| Connector size | 2 X 5 = 10 Pin | | | | |
| Connector type | JST-2.0mm-M-180 | | | | |
| Connector location | UART1 (COM5 for GPS Module when VDB-800 is installed) Baud Rate : 9600 | | | | |
| Connector pin definition | Pin | Signal | Pin | Signal | |
| | 1 | NC | 2 | COM5_RX | |
| | 3 | COM5_TX | 4 | NC | |
| | 5 | GND | 6 | NC | |
| | 7 | NC | 8 | GND | |
| | 9 | NC | 10 | +5V | |
| Connector map |  <p>The image shows a green PCB layout with various components. A red arrow points to a connector on the right side of the board, labeled "UART1 (COM5)".</p> | | | | |

2.6 LED connector

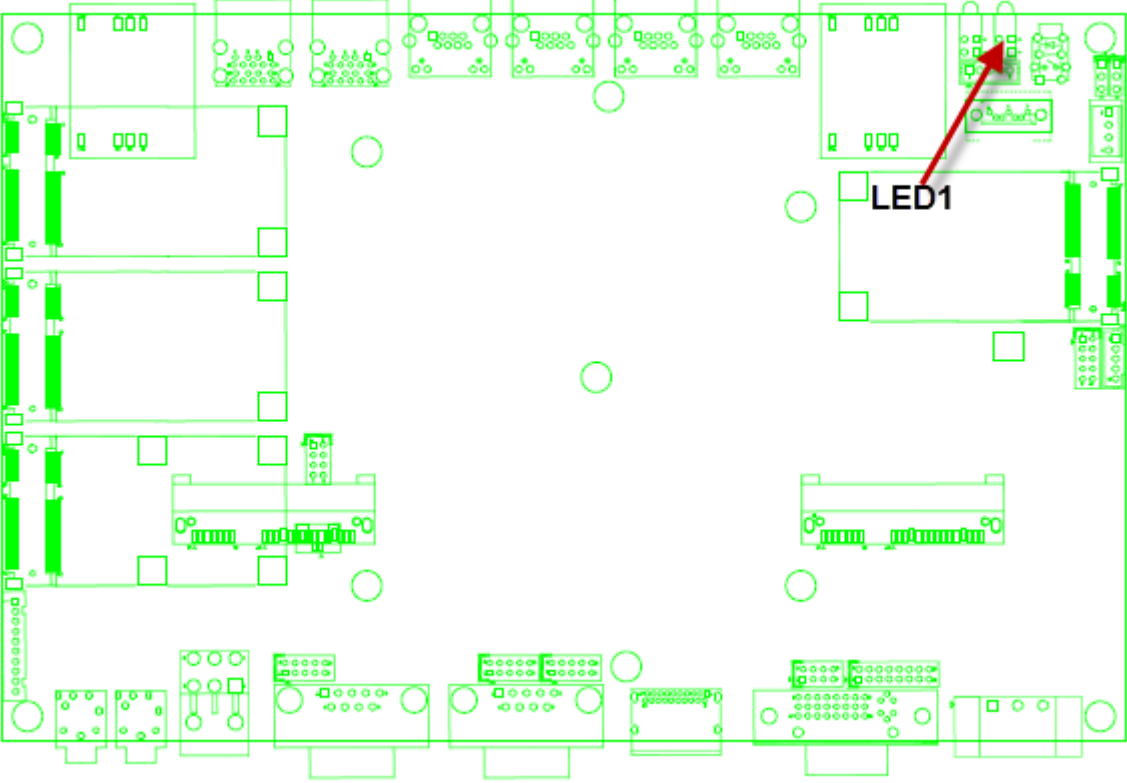
| | | | | | |
|--------------------------|---|------------|-----|-----------|--|
| Connector size | 2 X 2 = 4 Pin | | | | |
| Connector type | LED WITH HOUSING | | | | |
| Connector location | LED1 | | | | |
| Connector pin definition | Pin | Signal | Pin | Signal | |
| | A1 | 3.5G_LED_P | A2 | UPS_LED_P | |
| | C1 | 3.5G_LED_N | C2 | UPS_LED_N | |
| Connector map |  | | | | |

2.7 LED connector

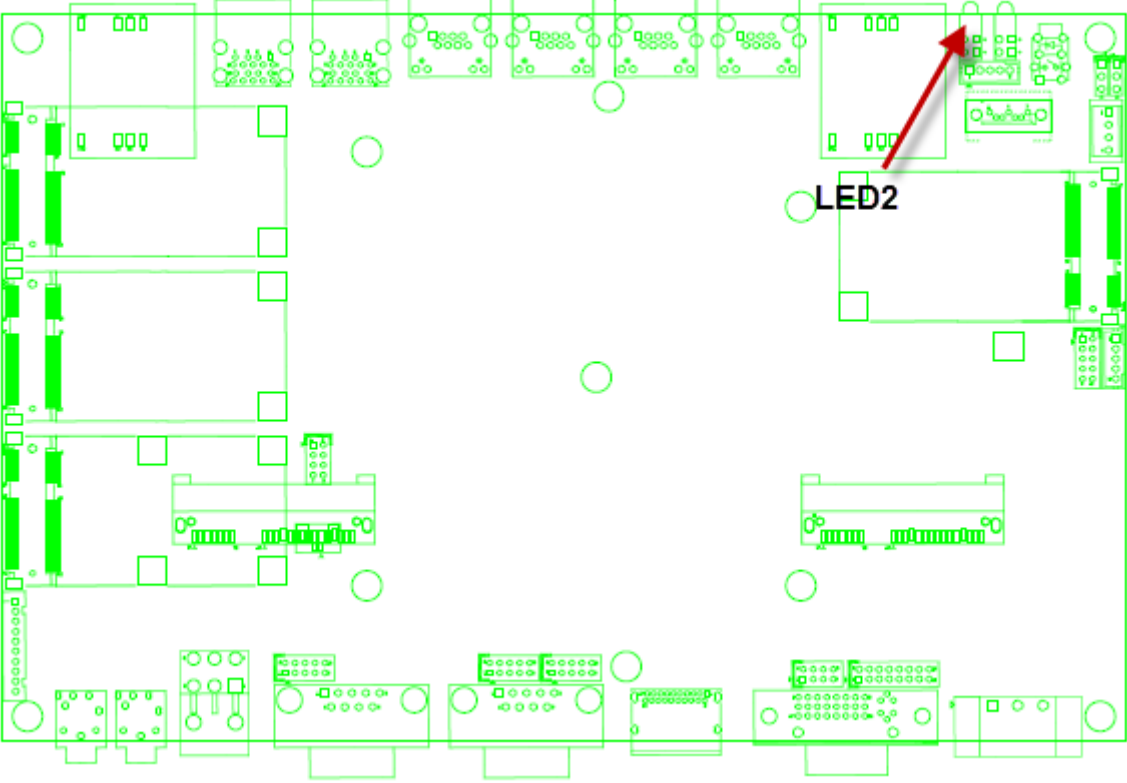
| | | | | | |
|--------------------------|---|-----------|-----|-----------|--|
| Connector size | 2 X 2 = 4 Pin | | | | |
| Connector type | LED WITH HOUSING | | | | |
| Connector location | LED2 | | | | |
| Connector pin definition | Pin | Signal | Pin | Signal | |
| | A1 | ACC_LED_P | A2 | HDD_LED_P | |
| | C1 | ACC_LED_N | C2 | HDD_LED_N | |
| Connector map |  | | | | |

2.8 COM connector

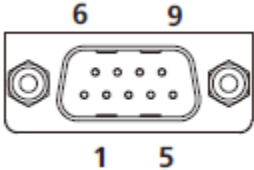
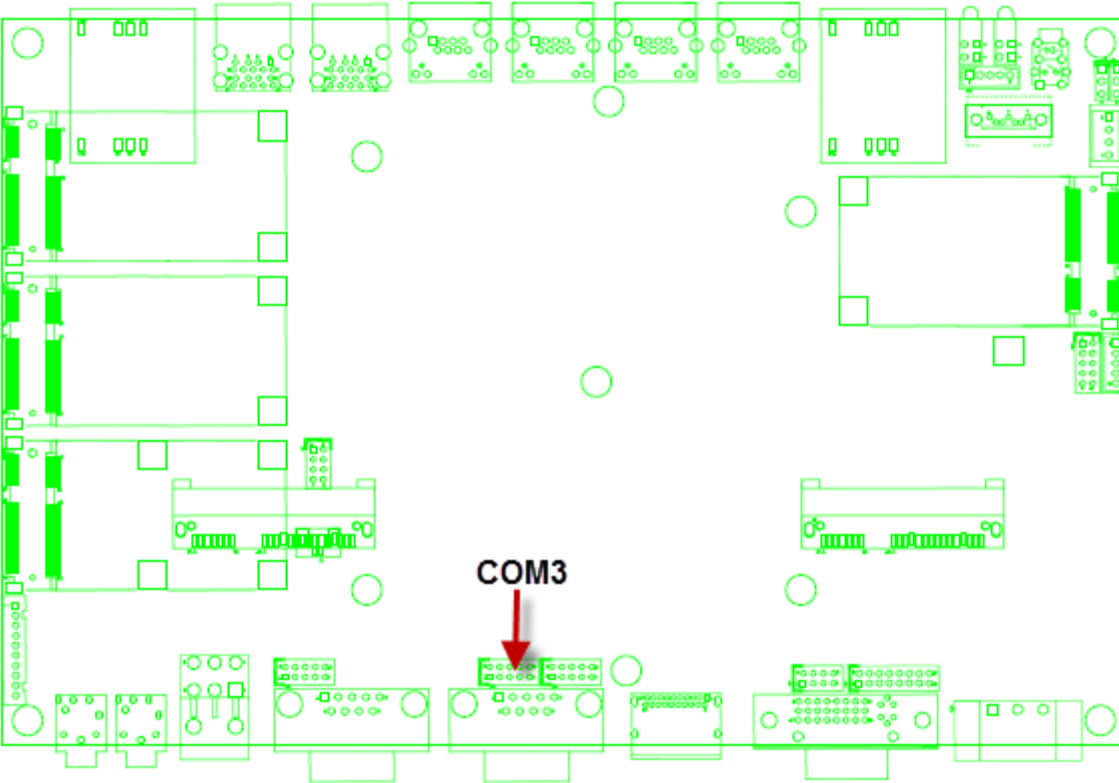
| | | | | | |
|--------------------------|--|----------|-----|----------|--|
| Connector size | 2 X 5 = 10 Pin | | | | |
| Connector type | JST-2.0mm-M-180 | | | | |
| Connector location | COM3  | | | | |
| Connector pin definition | Pin | Signal | Pin | Signal | |
| | 1 | COM3_DCD | 2 | COM3_RXD | |
| | 3 | COM3_TXD | 4 | COM3_DTR | |
| | 5 | GND | 6 | COM3_DSR | |
| | 7 | COM3_RTS | 8 | COM3_CTS | |
| | 9 | COM3_RI | 10 | GND | |
| Connector map |  | | | | |

2.9 COM connector

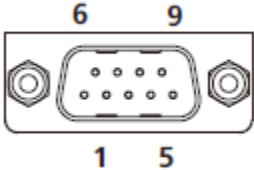
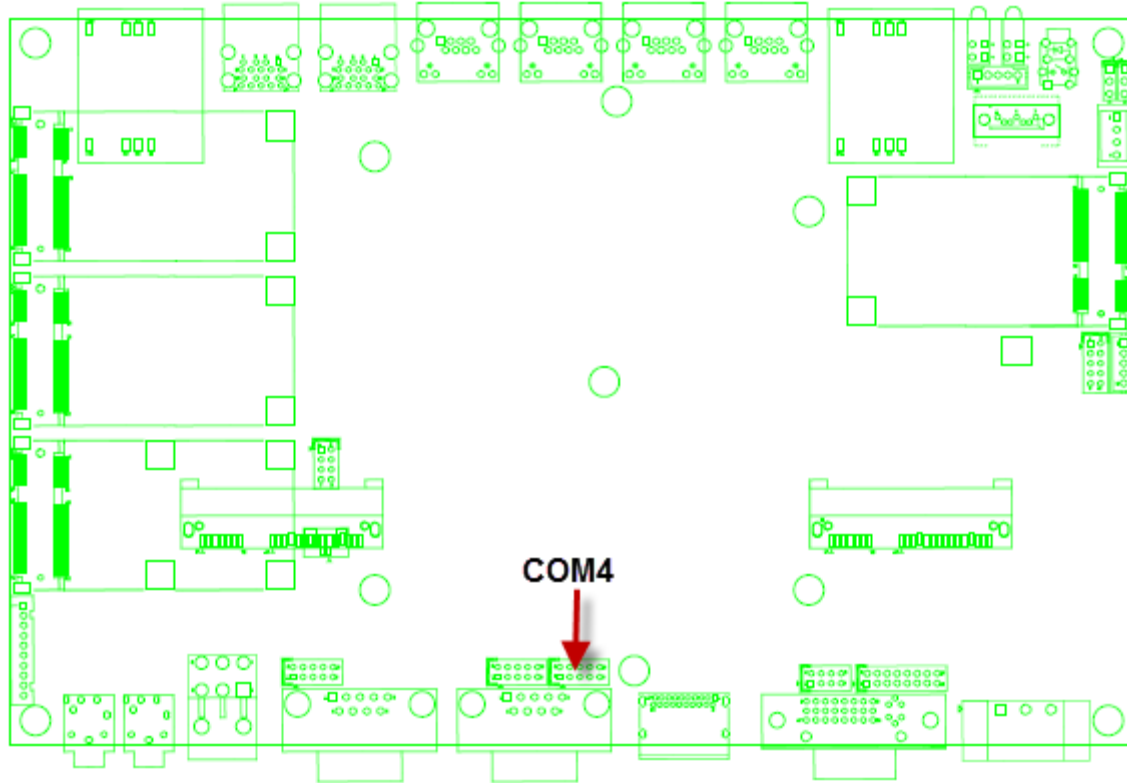
| | | | | | |
|--------------------------|--|----------|-----|-----------|--|
| Connector size | 2 X 5 = 10 Pin | | | | |
| Connector type | JST-2.0mm-M-180 | | | | |
| Connector location | COM4  | | | | |
| Connector pin definition | Pin | Signal | Pin | Signal | |
| | 1 | COM4_DCD | 2 | COM4_RXD | |
| | 3 | COM4_TXD | 4 | COM4_DTR | |
| | 5 | GND | 6 | COM4_DSR | |
| | 7 | COM4_RTS | 8 | COM43_CTS | |
| | 9 | COM4_RI | 10 | GND | |
| Connector map |  | | | | |

2.10 AUDIO connector

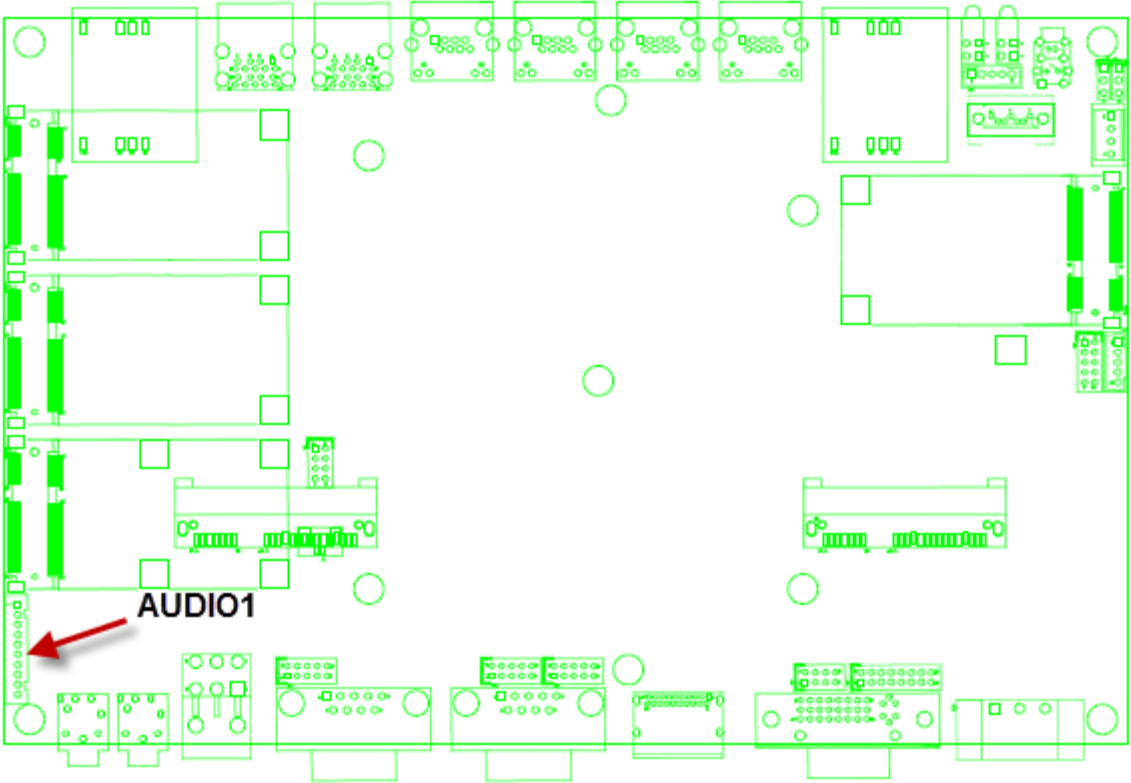
| | | | |
|--------------------------|---|----------|--|
| Connector size | 1 X 10 = 10 Pin | | |
| Connector type | JST-2.0mm-M-180 | | |
| Connector location | AUDIO1 | | |
| Connector pin definition | Pin | Signal | |
| | 1 | NC | |
| | 2 | NC | |
| | 3 | NC | |
| | 4 | NC | |
| | 5 | NC | |
| | 6 | NC | |
| | 7 | MIC_IN_L | |
| | 8 | MIC_IN_R | |
| | 9 | MIC-JD | |
| 10 | GND | | |
| Connector map |  | | |

2.11 SATA connector

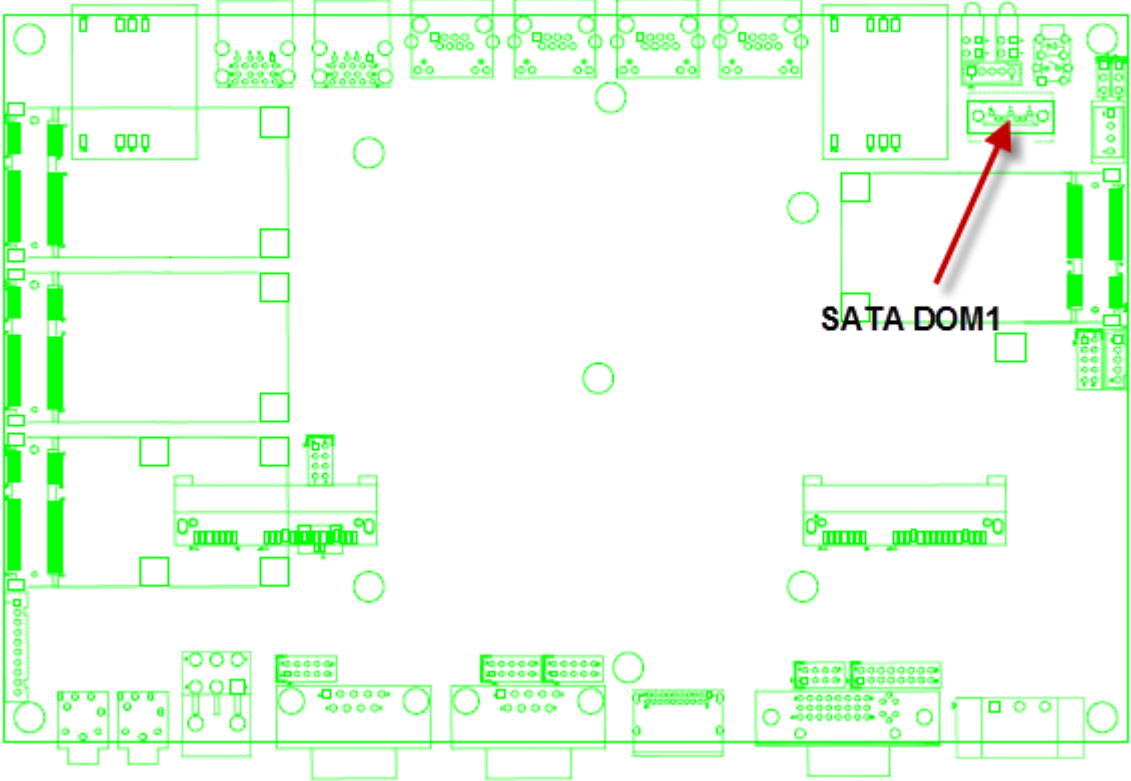
| | | | |
|--------------------------|---|-----------|--|
| Connector size | 1 X 7 = 7 Pin | | |
| Connector type | SATA 1.27mm-M-180D | | |
| Connector location | SATA DOM1 | | |
| Connector pin definition | Pin | Signal | |
| | 1 | GND | |
| | 2 | SATA_TXP2 | |
| | 3 | SATA_TXN2 | |
| | 4 | GND | |
| | 5 | SATA_RXN2 | |
| | 6 | SATA_RXP2 | |
| | 7 | GND | |
| Connector map |  <p>The image shows a green PCB layout with various components. A red arrow points to a specific connector footprint on the right side of the board, labeled "SATA DOM1". The footprint is a 7-pin connector. The rest of the board shows various other components and traces.</p> | | |

2.12 SATA connector

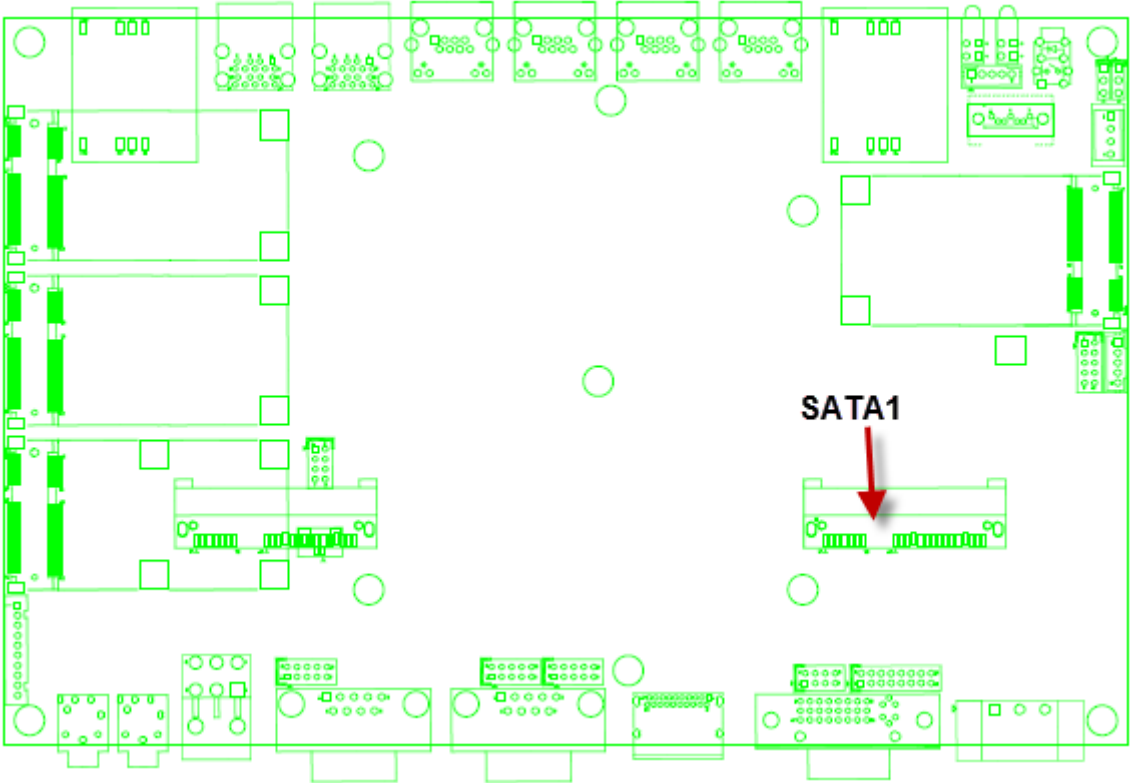
| | | | | | |
|--------------------------|---|-----------|-----|--------|--|
| Connector size | 1 X 7 = 7 Pin | | | | |
| Connector type | SATA 1.27mm-M-180D | | | | |
| Connector location | SATA1 | | | | |
| Connector pin definition | Pin | Signal | Pin | Signal | |
| | S1 | GND | P1 | NC | |
| | S2 | SATA_TXP0 | P2 | NC | |
| | S3 | SATA_TXN0 | P3 | NC | |
| | S4 | GND | P4 | GND | |
| | S5 | SATA_RXN0 | P5 | GND | |
| | S6 | SATA_RXP0 | P6 | GND | |
| | S7 | GND | P7 | +5V | |
| | | | P8 | +5V | |
| | | | P9 | +5V | |
| | | | P10 | NC | |
| | | | P11 | GND | |
| | | | P12 | GND | |
| | | | P13 | NC | |
| | | | P14 | NC | |
| | | P15 | NC | | |
| Connector map |  <p>The image shows a green PCB layout with various components. A red arrow points to a connector labeled 'SATA1' located in the lower right quadrant of the board.</p> | | | | |

2.13 SATA connector

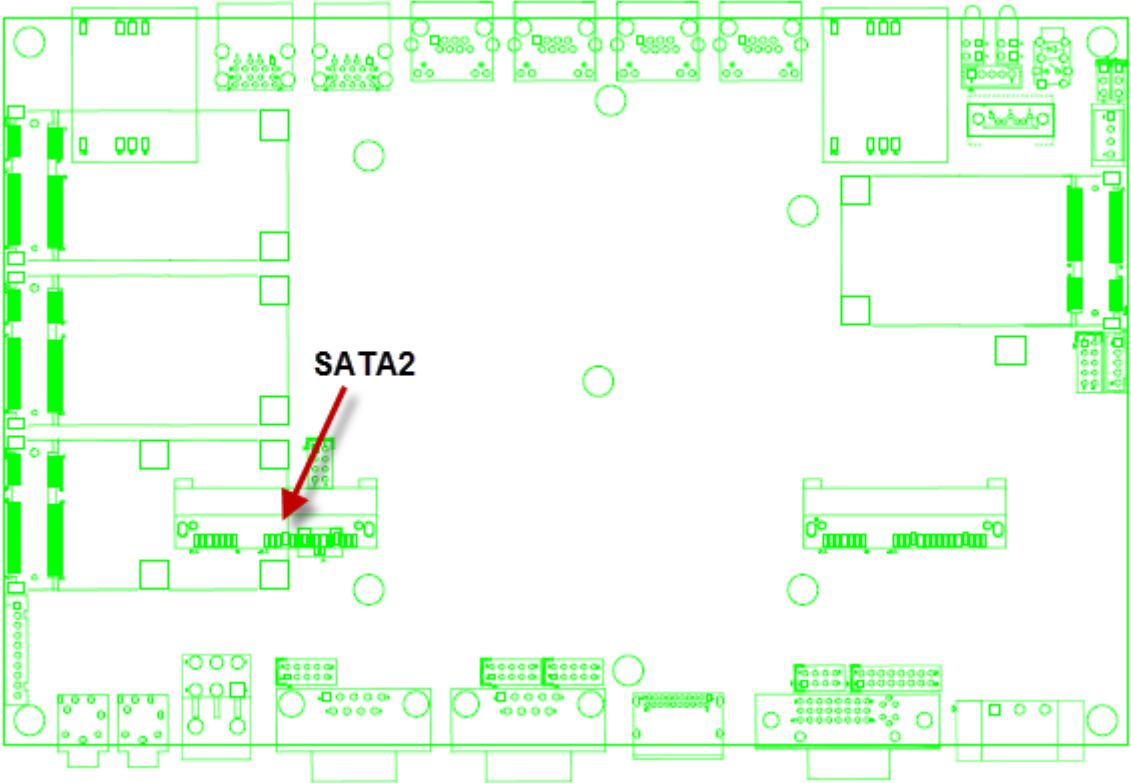
| | | | | | |
|--------------------------|--|-----------|-----|-----|--------|
| Connector size | 1 X 7 = 7 Pin | | | | |
| Connector type | SATA 1.27mm-M-180D | | | | |
| Connector location | SATA2 | | | | |
| Connector pin definition | Pin | Signal | | Pin | Signal |
| | S1 | GND | | P1 | NC |
| | S2 | SATA_TXP1 | | P2 | NC |
| | S3 | SATA_TXN1 | | P3 | NC |
| | S4 | GND | | P4 | GND |
| | S5 | SATA_RXN1 | | P5 | GND |
| | S6 | SATA_RXP1 | | P6 | GND |
| | S7 | GND | | P7 | +5V |
| | | | | P8 | +5V |
| | | | | P9 | +5V |
| | | | | P10 | NC |
| | | | | P11 | GND |
| | | | | P12 | GND |
| | | | | P13 | NC |
| | | | | P14 | NC |
| | | | P15 | NC | |
| Connector map |  | | | | |

2.14 Mini PCI-E connector

| | | | | |
|--------------------------|-----------------------|-------------------|-------|----------------|
| Connector size | 2 X 26 = 52 Pin | | | |
| Connector type | MINI PCI-E CON 9.2mmH | | | |
| Connector location | MINICARD1 | | | |
| Connector pin definition | Pin | Signal | Pin | Signal |
| | 1 | PCIE_WAKE# | 2 | 3VSB |
| | 3 | NC | 4 | GND |
| | 5 | NC | 6 | +1.5V |
| | 7 | MINICARD1_CLKREQ# | 8 | UIM_PWR |
| | 9 | GND | 10 | UIM_DAT |
| | 11 | NC | 12 | UIM_CLK |
| | 13 | NC | 14 | UIM_RST |
| | 15 | GND | 16 | NC |
| | 17 | NC | 18 | GND |
| | 19 | NC | 20 | MINICARD1_DIS# |
| | 21 | GND | 22 | PCIE_RST# |
| | 23 | NC | 24 | 3VSB |
| | 25 | NC | 26 | GND |
| | 27 | GND | 28 | +1.5V |
| | 29 | GND | 30 | SMB_CLK |
| | 31 | NC | 32 | SMB_DATA |
| | 33 | NC | 34 | GND |
| | 35 | GND | 36 | USB_4N |
| | 37 | GND | 38 | USB_4P |
| | 39 | 3VSB | 40 | GND |
| | 41 | 3VSB | 42 | LED_WWAN# |
| | 43 | GND | 44 | LED_WAN# |
| | 45 | NC | 46 | LED_WPAN# |
| 47 | NC | 48 | +1.5V | |
| 49 | NC | 50 | GND | |
| 51 | NC | 52 | 3VSB | |

Connector
map

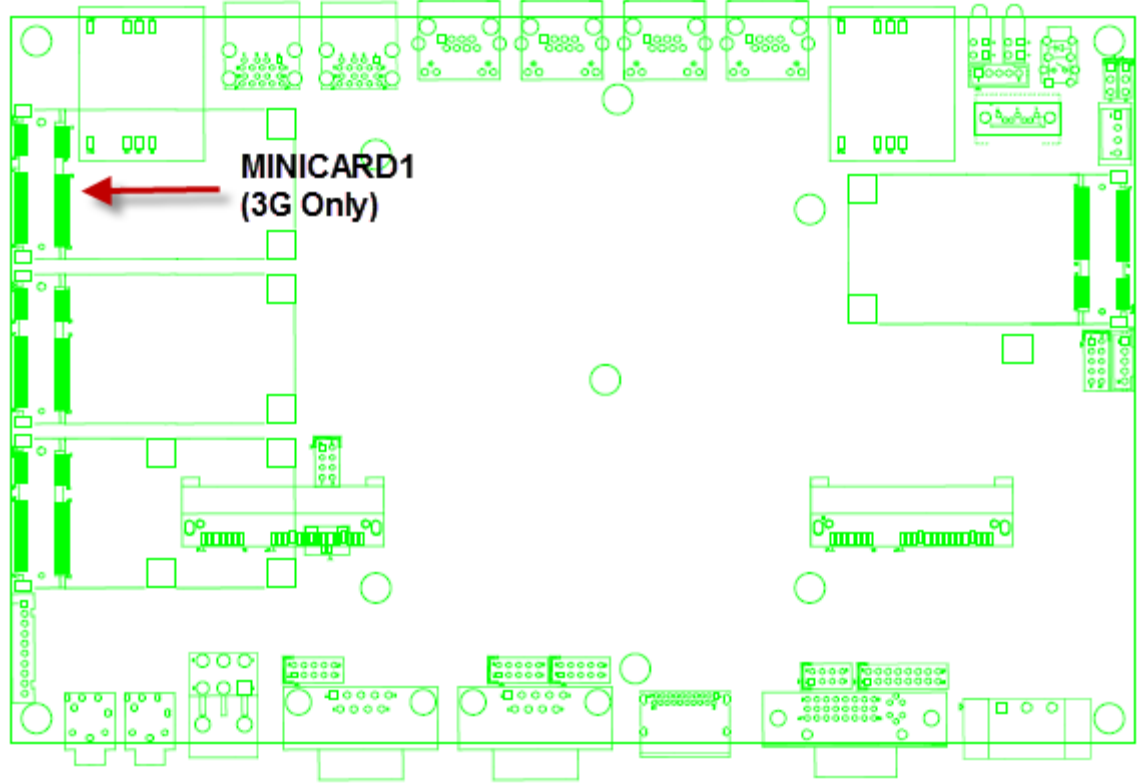

2.15 Mini PCI-E connector

| | | | | | |
|--------------------------|-----------------------|-------------------|-------|----------------|--|
| Connector size | 2 X 26 = 52 Pin | | | | |
| Connector type | MINI PCI-E CON 9.2mmH | | | | |
| Connector location | MINICARD2 | | | | |
| Connector pin definition | Pin | Signal | Pin | Signal | |
| | 1 | PCIE_WAKE# | 2 | 3VSB | |
| | 3 | NC | 4 | GND | |
| | 5 | NC | 6 | +1.5V | |
| | 7 | MINICARD2_CLKREQ# | 8 | UIM_PWR | |
| | 9 | GND | 10 | UIM_DAT | |
| | 11 | PCIE_MCARD2_CLK_N | 12 | UIM_CLK | |
| | 13 | PCIE_MCARD2_CLK_P | 14 | UIM_RST | |
| | 15 | GND | 16 | NC | |
| | 17 | NC | 18 | GND | |
| | 19 | NC | 20 | MINICARD2_DIS# | |
| | 21 | GND | 22 | PCIE_RST# | |
| | 23 | PCIE_MCARD2_RX_N | 24 | 3VSB | |
| | 25 | PCIE_MCARD2_RX_P | 26 | GND | |
| | 27 | GND | 28 | +1.5V | |
| | 29 | GND | 30 | SMB_CLK | |
| | 31 | PCIE_MCARD2_TX_N | 32 | SMB_DATA | |
| | 33 | PCIE_MCARD2_TX_P | 34 | GND | |
| | 35 | GND | 36 | USB_5N | |
| | 37 | GND | 38 | USB_5P | |
| | 39 | 3VSB | 40 | GND | |
| | 41 | 3VSB | 42 | LED_WWAN# | |
| | 43 | GND | 44 | LED_WAN# | |
| | 45 | NC | 46 | LED_WPAN# | |
| 47 | NC | 48 | +1.5V | | |
| 49 | NC | 50 | GND | | |
| 51 | NC | 52 | 3VSB | | |

Connector
map

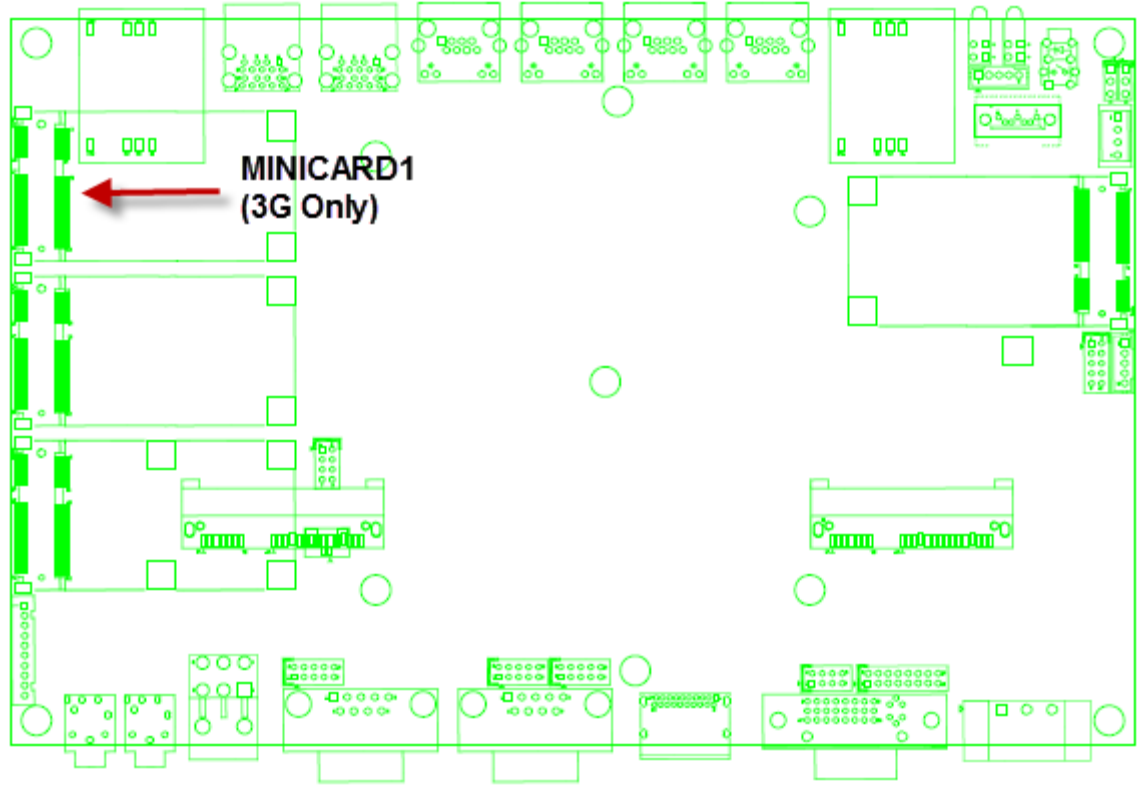

2.16 Mini PCI-E connector

| | | | | | |
|--------------------------|-----------------------|-------------------|-------|----------------|--|
| Connector size | 2 X 26 = 52 Pin | | | | |
| Connector type | MINI PCI-E CON 9.2mmH | | | | |
| Connector location | MINICARD3 | | | | |
| Connector pin definition | Pin | Signal | Pin | Signal | |
| | 1 | PCIE_WAKE# | 2 | 3VSB | |
| | 3 | NC | 4 | GND | |
| | 5 | NC | 6 | +1.5V | |
| | 7 | MINICARD3_CLKREQ# | 8 | NC | |
| | 9 | GND | 10 | NC | |
| | 11 | PCIE_MCARD3_CLK_N | 12 | NC | |
| | 13 | PCIE_MCARD3_CLK_P | 14 | NC | |
| | 15 | GND | 16 | NC | |
| | 17 | NC | 18 | GND | |
| | 19 | NC | 20 | MINICARD3_DIS# | |
| | 21 | GND | 22 | PCIE_RST# | |
| | 23 | PCIE_MCARD3_RX_N | 24 | 3VSB | |
| | 25 | PCIE_MCARD3_RX_P | 26 | GND | |
| | 27 | GND | 28 | +1.5V | |
| | 29 | GND | 30 | SMB_CLK | |
| | 31 | PCIE_MCARD3_TX_N | 32 | SMB_DATA | |
| | 33 | PCIE_MCARD3_TX_P | 34 | GND | |
| | 35 | GND | 36 | USB_6N | |
| | 37 | GND | 38 | USB_6P | |
| | 39 | 3VSB | 40 | GND | |
| | 41 | 3VSB | 42 | NC | |
| | 43 | GND | 44 | NC | |
| | 45 | NC | 46 | NC | |
| 47 | NC | 48 | +1.5V | | |
| 49 | NC | 50 | GND | | |
| 51 | NC | 52 | 3VSB | | |

Connector
map

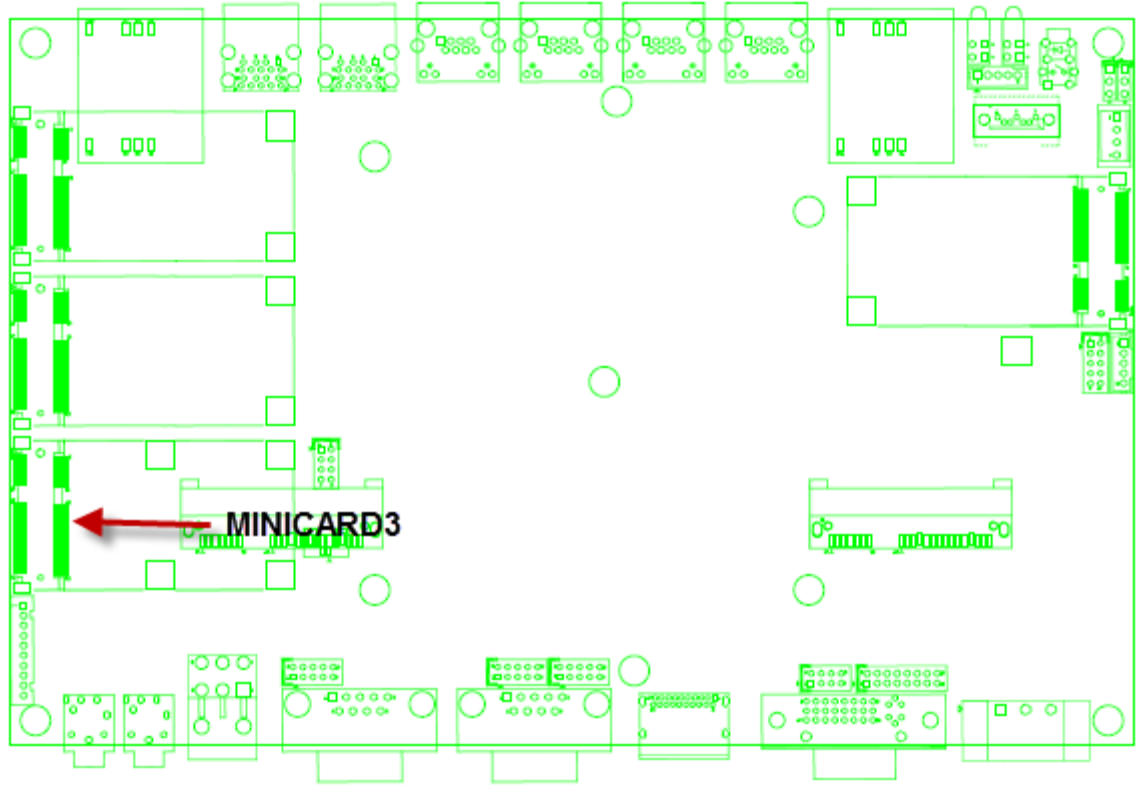

2.17 Mini PCI-E connector

| | | | | | |
|--------------------------|-----------------------|-------------------|-------|----------------|--|
| Connector size | 2 X 26 = 52 Pin | | | | |
| Connector type | MINI PCI-E CON 9.2mmH | | | | |
| Connector location | MINICARD4 | | | | |
| Connector pin definition | Pin | Signal | Pin | Signal | |
| | 1 | PCIE_WAKE# | 2 | 3VSB | |
| | 3 | NC | 4 | GND | |
| | 5 | NC | 6 | +1.5V | |
| | 7 | MINICARD4_CLKREQ# | 8 | NC | |
| | 9 | GND | 10 | NC | |
| | 11 | PCIE_MCARD4_CLK_N | 12 | NC | |
| | 13 | PCIE_MCARD4_CLK_P | 14 | NC | |
| | 15 | GND | 16 | NC | |
| | 17 | NC | 18 | GND | |
| | 19 | NC | 20 | MINICARD4_DIS# | |
| | 21 | GND | 22 | PCIE_RST# | |
| | 23 | PCIE_MCARD4_RX_N | 24 | 3VSB | |
| | 25 | PCIE_MCARD4_RX_P | 26 | GND | |
| | 27 | GND | 28 | +1.5V | |
| | 29 | GND | 30 | SMB_CLK | |
| | 31 | PCIE_MCARD4_TX_N | 32 | SMB_DATA | |
| | 33 | PCIE_MCARD4_TX_P | 34 | GND | |
| | 35 | GND | 36 | NC | |
| | 37 | GND | 38 | NC | |
| | 39 | 3VSB | 40 | GND | |
| | 41 | 3VSB | 42 | NC | |
| | 43 | GND | 44 | NC | |
| | 45 | NC | 46 | NC | |
| 47 | NC | 48 | +1.5V | | |
| 49 | NC | 50 | GND | | |
| 51 | NC | 52 | 3VSB | | |

Connector
map

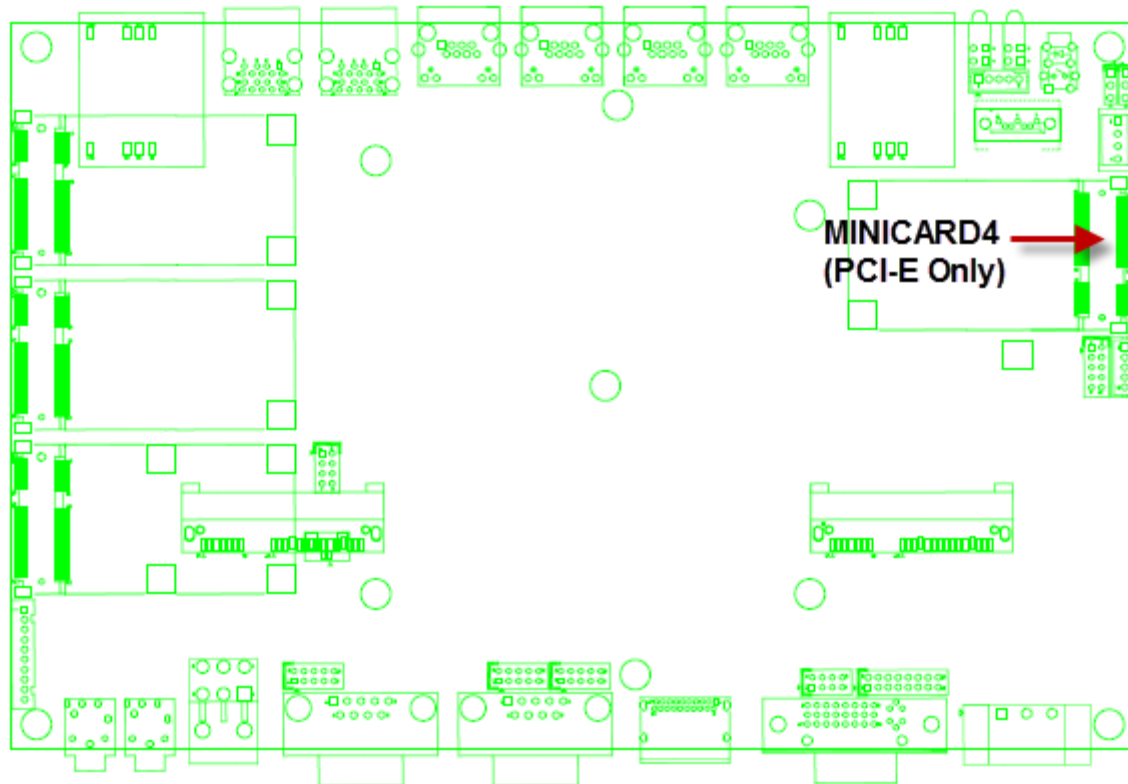

2.18 POWER Input connector

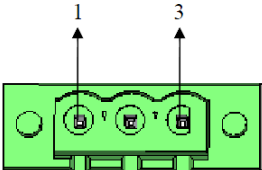
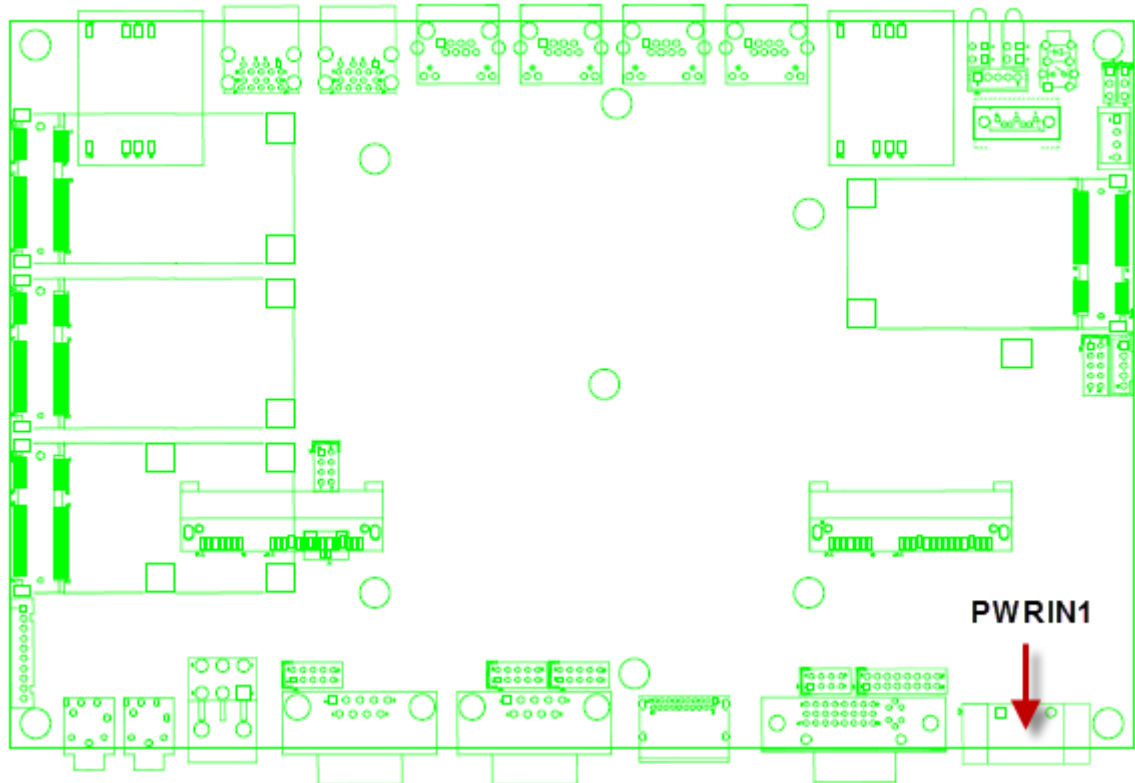
| | | | |
|--------------------------|--|-------------|--|
| Connector size | 1 X 4 = 4 Pin | | |
| Connector type | WAFER 2.54mm-M-180 | | |
| Connector location | PWRIN1  | | |
| Connector pin definition | Pin | Signal | |
| | 1 | GND | |
| | 2 | VIN (9-32V) | |
| | 3 | IGNITION | |
| Connector map |  | | |

2.19 SATA power connector

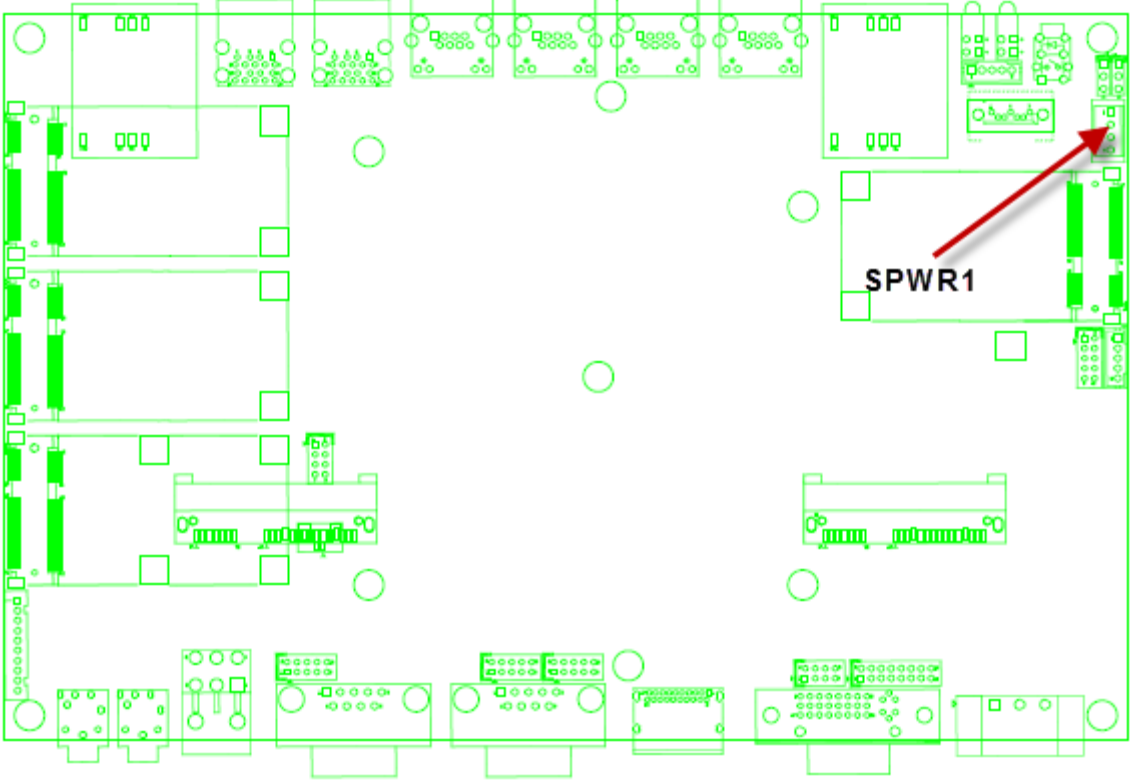
| | | | |
|--------------------------|---|---------------|--|
| Connector size | 1 X 4 = 4 Pin | | |
| Connector type | WAFER 2.54mm-M-180 | | |
| Connector location | SPWR1 | | |
| Connector pin definition | Pin | Signal | |
| | 1 | +5V | |
| | 2 | GND | |
| | 3 | GND | |
| | 4 | +12V | |
| Connector map |  | | |

2.20 UPS power connector

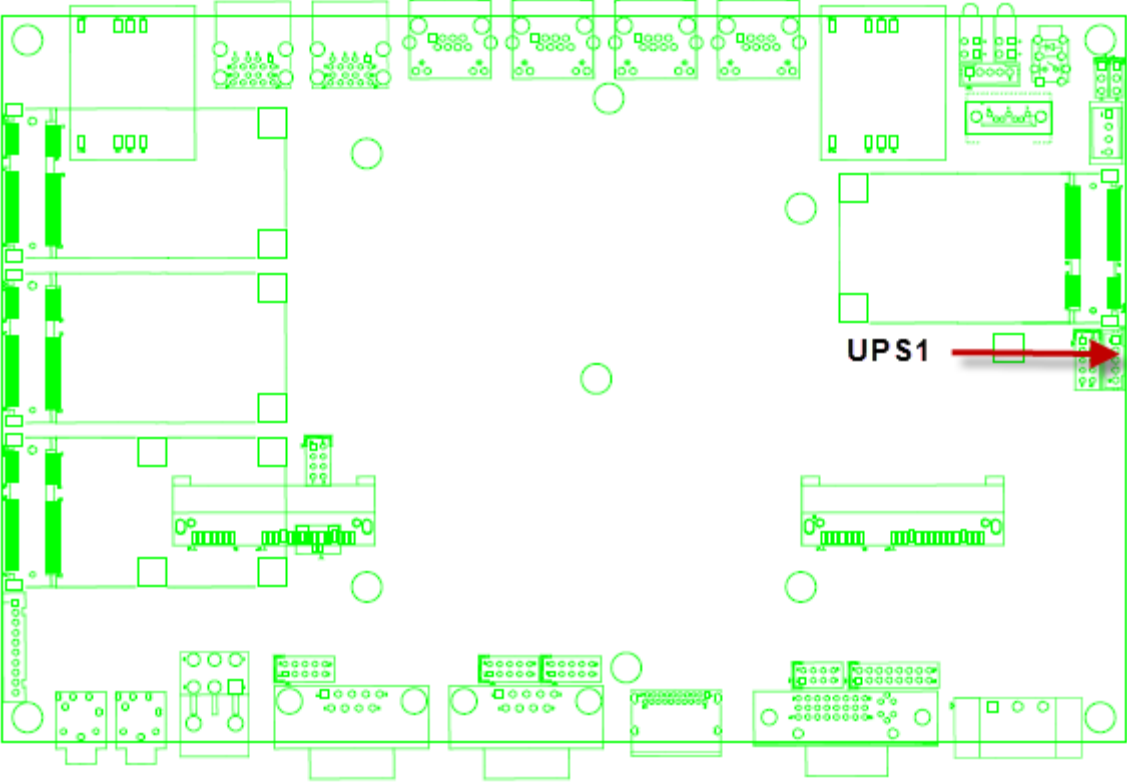
| | | | |
|--------------------------|---|---------------|--|
| Connector size | 1 X 4 = 4 Pin | | |
| Connector type | WAFER 2.54mm-M-180 | | |
| Connector location | UPS1 | | |
| Connector pin definition | Pin | Signal | |
| | 1 | +12V | |
| | 2 | +12V | |
| | 3 | GND | |
| 4 | GND | | |
| Connector map |  | | |

(3) External connector specification

| 3.1 USB connector | | | | | |
|--------------------------|--|----------|----------|----------|--|
| Connector size | 8 Pin | | | | |
| Connector type | USB3.0 Type A | | | | |
| Connector location | USB3 | | | | |
| Connector pin definition | Pin | Signal | Pin | Signal | |
| | 1 | 5VSB | 2 | USB0_N | |
| | 3 | USB0_P | 4 | GND | |
| | 5 | SSRX0_ON | 6 | SSRX0_OP | |
| | 7 | GND | 8 | SSTX0_ON | |
| | 9 | SSTX0_OP | 10 | 5VSB | |
| | 11 | USB1_N | 12 | USB1_P | |
| | 13 | GND | 14 | SSRX1_ON | |
| | 15 | SSRX1_OP | 16 | GND | |
| 17 | SSTX1_ON | 18 | SSTX1_OP | | |
| Connector map | <p>The diagram shows a green-tinted PCB layout with various components and connectors. A red arrow points to a specific connector labeled "USB3" on the board.</p> | | | | |

3.2 USB connector

| | | | | | |
|--------------------------|---|----------|----------|-----------|--|
| Connector size | 8 Pin | | | | |
| Connector type | USB3.0 Type A | | | | |
| Connector location | USB4 | | | | |
| Connector pin definition | Pin | Signal | Pin | Signal | |
| | 1 | 5VSB | 2 | USB2_N | |
| | 3 | USB2_P | 4 | GND | |
| | 5 | SSRX2_ON | 6 | SSRX2_OP | |
| | 7 | GND | 8 | SSTX20_ON | |
| | 9 | SSTX2_OP | 10 | 5VSB | |
| | 11 | USB3_N | 12 | USB3_P | |
| | 13 | GND | 14 | SSRX3_ON | |
| | 15 | SSRX3_OP | 16 | GND | |
| 17 | SSTX3_ON | 18 | SSTX3_OP | | |
| Connector map | <p>The image shows a green PCB layout with various components and traces. A red arrow points to a specific connector footprint on the top edge of the board, which is labeled "USB4". The footprint is a rectangular array of pins. The rest of the board shows various other components, including what appears to be a USB controller chip and other peripheral components, all rendered in green outlines.</p> | | | | |

3.3 LAN connector

| | | | | | |
|--------------------------|-------------|------------|-----|-----------------|--|
| Connector size | 12 Pin | | | | |
| Connector type | RJ45+LED | | | | |
| Connector location | LAN1 | | | | |
| Connector pin definition | Pin | Signal | Pin | Signal | |
| | 1 | LAN0_MDI0P | 2 | LAN0_MDI0N | |
| | 3 | LAN0_MDI1P | 4 | LAN0_MDI2P | |
| | 5 | LAN0_MDI2N | 6 | LAN0_MDI1N | |
| | 7 | LAN0_MDI3P | 8 | LAN0_MDI3N | |
| | 9 | LAN0_ACT# | 10 | LAN0_ACTP W | |
| | 11 | LAN0_LINK# | 12 | LAN0_LINKP W | |

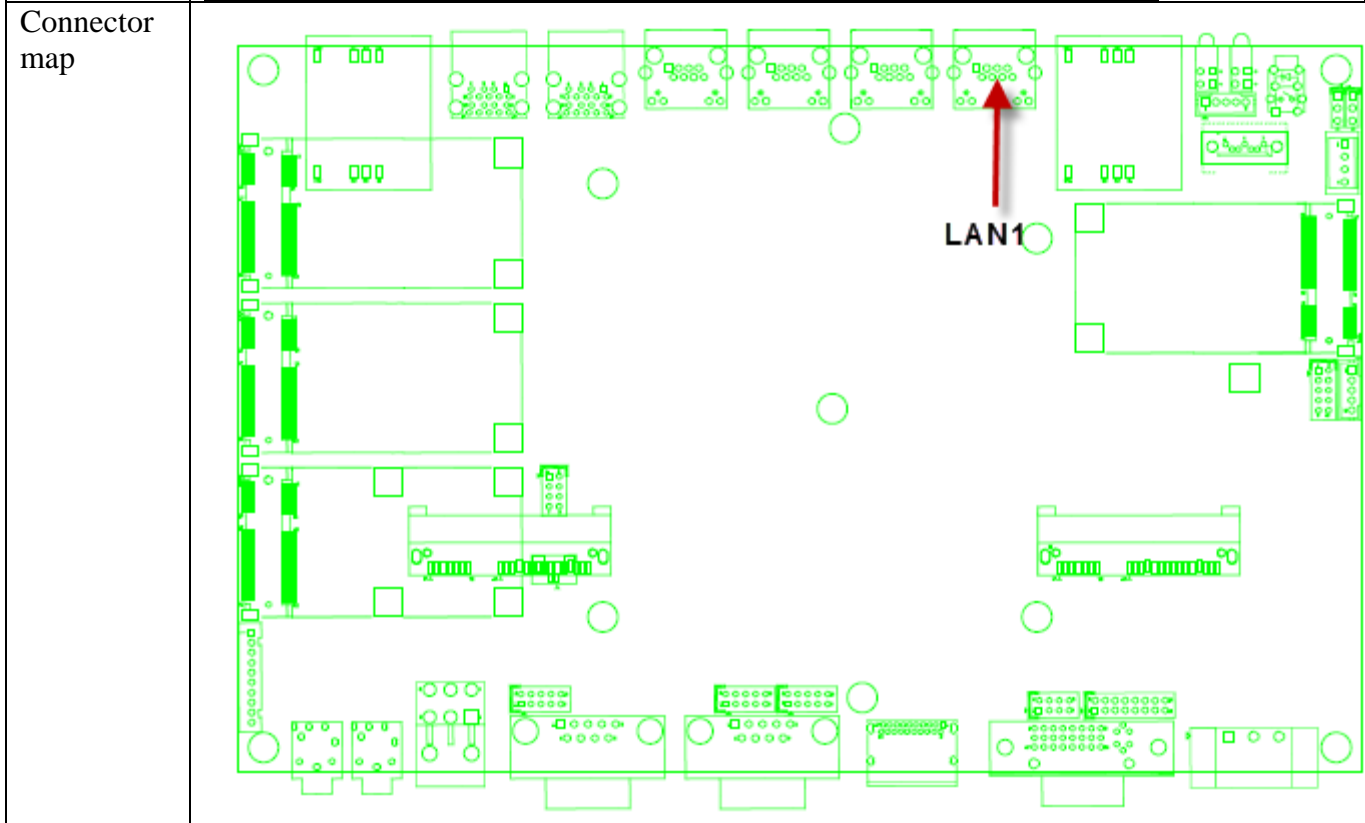

3.4 LAN connector

| | | | | | |
|--------------------------|--|------------|-----|-------------|--|
| Connector size | 12 Pin | | | | |
| Connector type | RJ45+LED | | | | |
| Connector location | LAN2 | | | | |
| Connector pin definition | Pin | Signal | Pin | Signal | |
| | 1 | LAN1_MDI0P | 2 | LAN1_MDI0N | |
| | 3 | LAN1_MDI1P | 4 | LAN1_MDI2P | |
| | 5 | LAN1_MDI2N | 6 | LAN1_MDI1N | |
| | 7 | LAN1_MDI3P | 8 | LAN1_MDI3N | |
| | 9 | LAN1_ACT# | 10 | LAN1_ACTPW | |
| | 11 | LAN1_LINK# | 12 | LAN1_LINKPW | |
| Connector map | <p>The diagram shows a green PCB layout with various components. A red arrow points to a specific footprint labeled 'LAN2' in the center of the board.</p> | | | | |

3.5 LAN connector

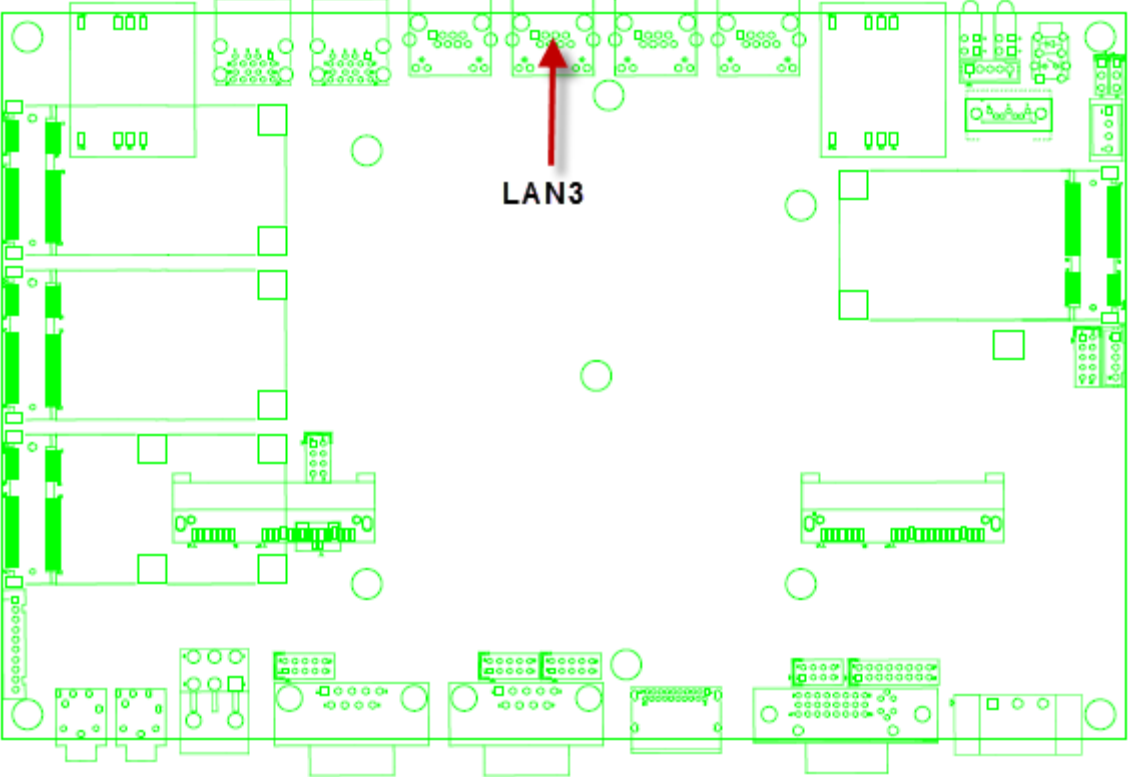
| | | | | | |
|--------------------------|---|------------|-----|-------------|--|
| Connector size | 12 Pin | | | | |
| Connector type | RJ45+LED | | | | |
| Connector location | LAN3 | | | | |
| Connector pin definition | Pin | Signal | Pin | Signal | |
| | 1 | LAN2_MDI0P | 2 | LAN2_MDI0N | |
| | 3 | LAN2_MDI1P | 4 | LAN2_MDI2P | |
| | 5 | LAN2_MDI2N | 6 | LAN2_MDI1N | |
| | 7 | LAN2_MDI3P | 8 | LAN2_MDI3N | |
| | 9 | LAN2_ACT# | 10 | LAN2_ACTPW | |
| | 11 | LAN2_LINK# | 12 | LAN2_LINKPW | |
| Connector map |  | | | | |

3.6 LAN connector

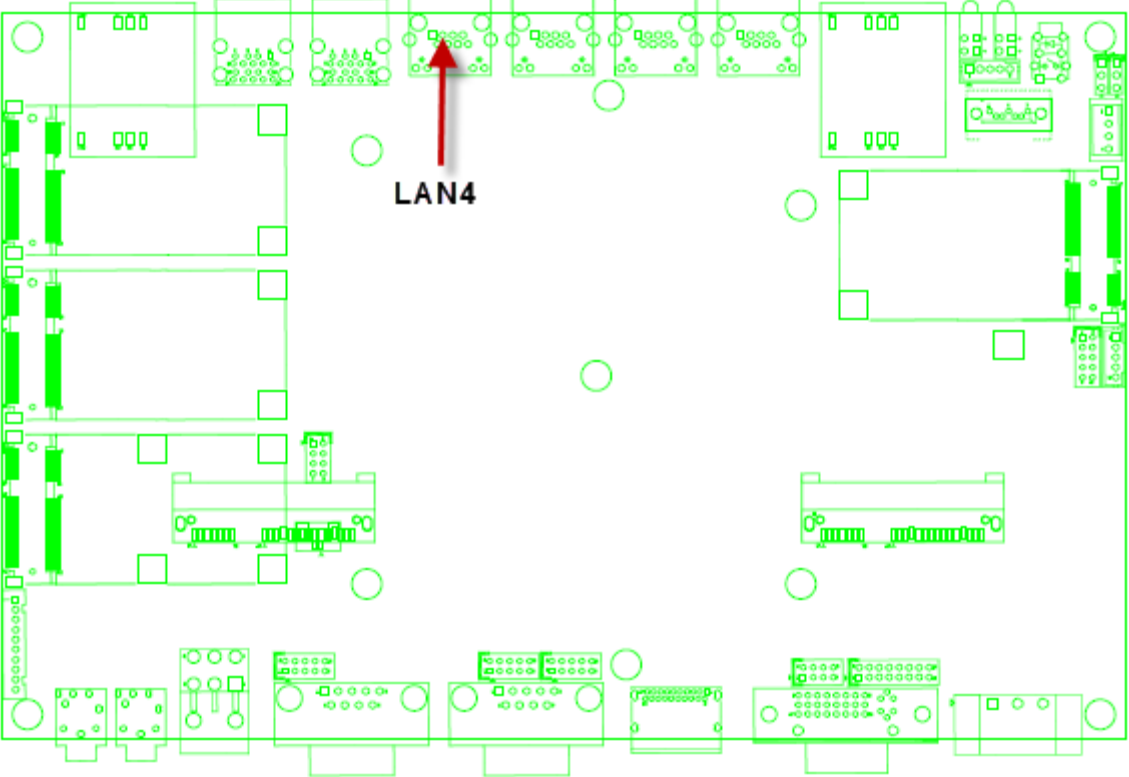
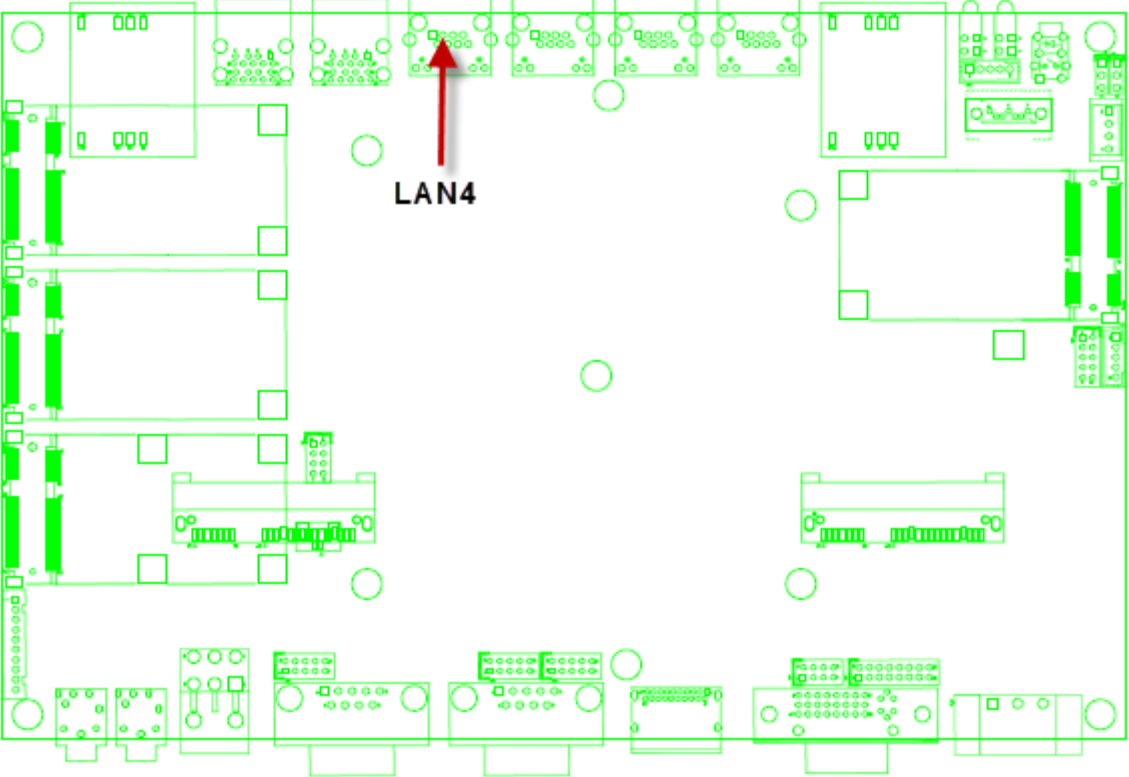
| | | | | | |
|--------------------------|---|------------|-----|-------------|---|
| Connector size | 12 Pin | | | | |
| Connector type | RJ45+LED | | | | |
| Connector location | LAN4 | | | | |
| Connector pin definition | Pin | Signal | Pin | Signal |  |
| | 1 | LAN3_MDI0P | 2 | LAN3_MDI0N | |
| | 3 | LAN3_MDI1P | 4 | LAN3_MDI2P | |
| | 5 | LAN3_MDI2N | 6 | LAN3_MDI1N | |
| | 7 | LAN3_MDI3P | 8 | LAN3_MDI3N | |
| | 9 | LAN3_ACT# | 10 | LAN3_ACTPW | |
| | 11 | LAN3_LINK# | 12 | LAN3_LINKPW | |
| Connector map |  | | | | |

3.7 DVI-I connector

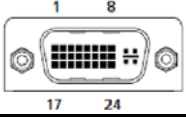
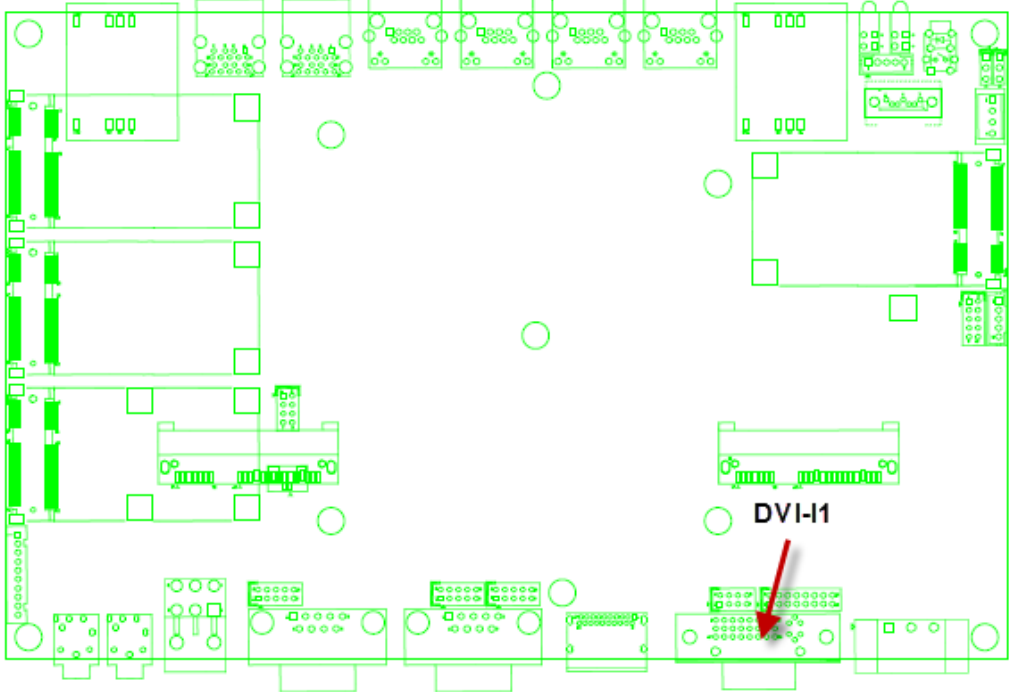
| | | | | |
|--------------------------|--|--------------|-----|-------------|
| Connector size | 50 Pin | | | |
| Connector type | DVI-I | | | |
| Connector location | DVI-I1  | | | |
| Connector pin definition | Pin | Signal | Pin | Signal |
| | 1 | DVI_TX2_N | 2 | DVI_TX2_P |
| | 3 | GND | 4 | 5VSB |
| | 5 | +12V | 6 | DVI_DDC_CLK |
| | 7 | DVI_DDC_DATA | 8 | CRT_VSYNC |
| | 9 | DVI_TX1_N | 10 | DVI_TX1_P |
| | 11 | GND | 12 | USB_7N |
| | 13 | USB_7P | 14 | +5V |
| | 15 | GND | 16 | DVI_HPD |
| | 17 | DVI_TX0_N | 18 | DVI_TX0_P |
| | 19 | GND | 20 | CRT_DAC_SDA |
| | 21 | CRT_DAC_SCL | 22 | NC |
| | 23 | DVI_CLK_P | 24 | DVI_CLK_N |
| | C1 | CRT_RED | C2 | CRT_GREEN |
| | C3 | CRT_BLUE | C4 | CRT_HSYNC |
| | C5 | CRT_DET | C6 | GND |
| Connector map |  | | | |

3.8 DP connector

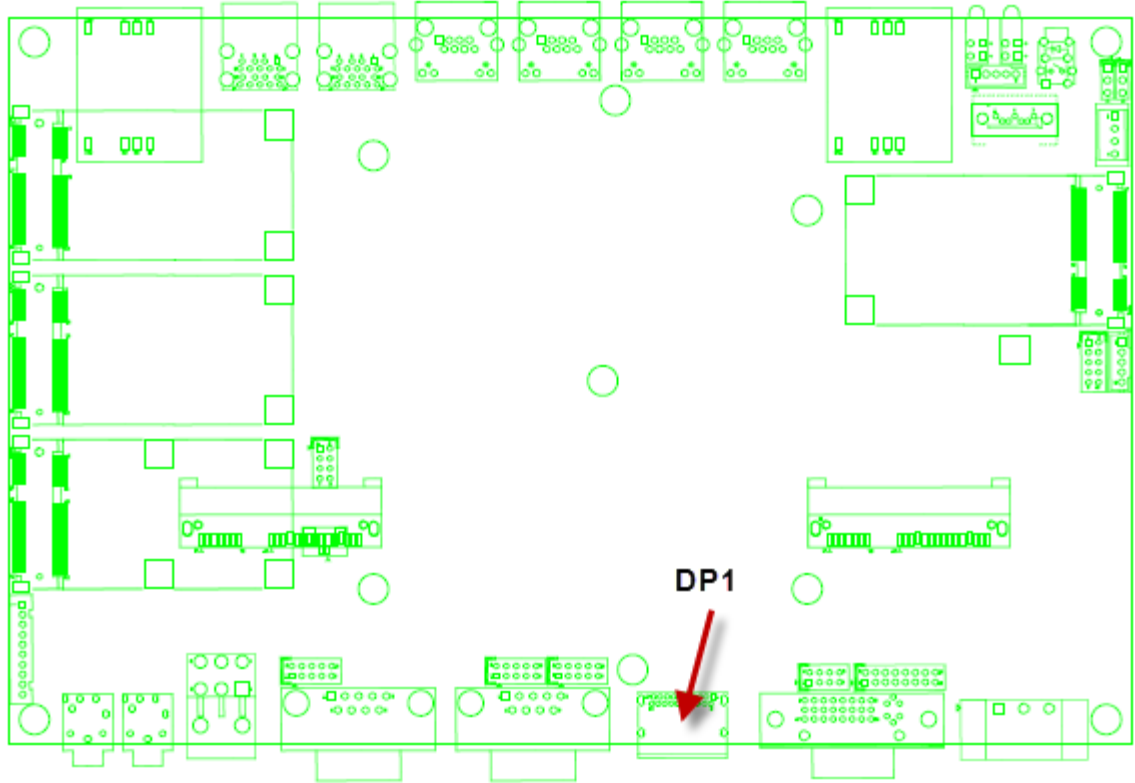
| | | | | | |
|--------------------------|--|---------------|----------|-------------|--|
| Connector size | 20 Pin | | | | |
| Connector type | Display port | | | | |
| Connector location | DP1 | | | | |
| Connector pin definition | Pin | Signal | Pin | Signal | |
| | 1 | DP2_LANE_0P | 2 | GND | |
| | 3 | DP2_LANE_0N | 4 | DP2_LANE_1P | |
| | 5 | GND | 6 | DP2_LANE_1N | |
| | 7 | DP2_LANE_2P | 8 | GND | |
| | 9 | DP2_LANE_2N | 10 | DP2_LANE_3P | |
| | 11 | GND | 12 | DP2_LANE_3N | |
| | 13 | DP2_AUX_EN# | 14 | GND | |
| | 15 | DP2_AUXP_CLK | 16 | GND | |
| | 17 | DP2_AUXN_DATA | 18 | DP2_HPDP | |
| 19 | GND | 20 | DP2_VCC3 | | |
| Connector map |  <p>The image shows a green PCB layout with various components and traces. A red arrow points to a specific connector footprint on the bottom edge of the board, which is labeled 'DP1'. The footprint is a rectangular area with multiple pins and internal connections.</p> | | | | |

3.9 COM connector

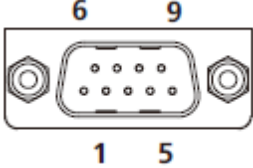
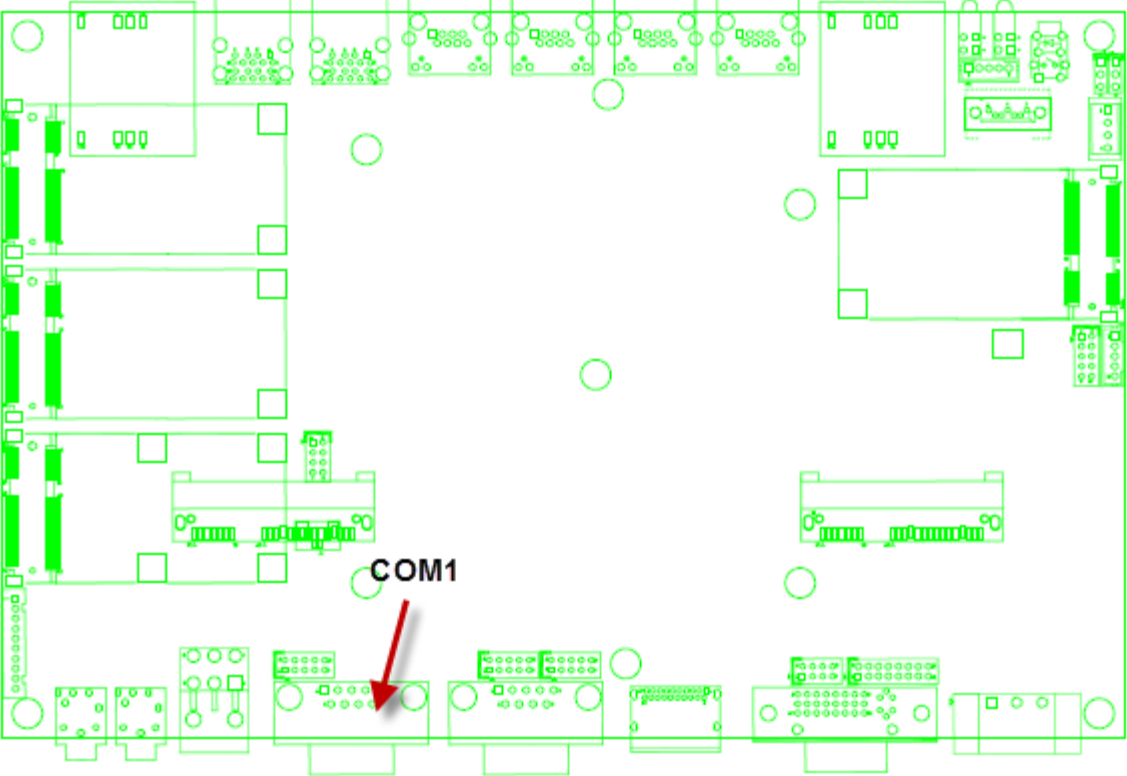
| Connector size | 9 Pin | | | | | | | | | | | | | | | | | | | | | | | | | | | |
|--------------------------|---|-----|---------------------------------------|-----|--------|---|---|---|---------------------------------------|---|----------|---|----------|---|-----|---|----------|---|----------|---|----------|---|----------|--|--|--|--|--|
| Connector type | DSUB | | | | | | | | | | | | | | | | | | | | | | | | | | | |
| Connector location | COM1  | | | | | | | | | | | | | | | | | | | | | | | | | | | |
| Connector pin definition | <table border="1"> <thead> <tr> <th>Pin</th> <th>Signal</th> <th>Pin</th> <th>Signal</th> </tr> </thead> <tbody> <tr> <td>1</td> <td>COM1_DCD / <i>(RS-485_TXD-/RXD-)</i></td> <td>2</td> <td>COM1_RXD <i>(RS-485_TXD+/RXD+)</i></td> </tr> <tr> <td>3</td> <td>COM1_TXD</td> <td>4</td> <td>COM1_DTR</td> </tr> <tr> <td>5</td> <td>GND</td> <td>6</td> <td>COM1_DSR</td> </tr> <tr> <td>7</td> <td>COM1_RTS</td> <td>8</td> <td>COM1_CTS</td> </tr> <tr> <td>9</td> <td>COM1_RI#</td> <td></td> <td></td> </tr> </tbody> </table> | Pin | Signal | Pin | Signal | 1 | COM1_DCD / <i>(RS-485_TXD-/RXD-)</i> | 2 | COM1_RXD <i>(RS-485_TXD+/RXD+)</i> | 3 | COM1_TXD | 4 | COM1_DTR | 5 | GND | 6 | COM1_DSR | 7 | COM1_RTS | 8 | COM1_CTS | 9 | COM1_RI# | | | | | |
| Pin | Signal | Pin | Signal | | | | | | | | | | | | | | | | | | | | | | | | | |
| 1 | COM1_DCD / <i>(RS-485_TXD-/RXD-)</i> | 2 | COM1_RXD <i>(RS-485_TXD+/RXD+)</i> | | | | | | | | | | | | | | | | | | | | | | | | | |
| 3 | COM1_TXD | 4 | COM1_DTR | | | | | | | | | | | | | | | | | | | | | | | | | |
| 5 | GND | 6 | COM1_DSR | | | | | | | | | | | | | | | | | | | | | | | | | |
| 7 | COM1_RTS | 8 | COM1_CTS | | | | | | | | | | | | | | | | | | | | | | | | | |
| 9 | COM1_RI# | | | | | | | | | | | | | | | | | | | | | | | | | | | |
| Connector map |  | | | | | | | | | | | | | | | | | | | | | | | | | | | |

3.10 COM connector

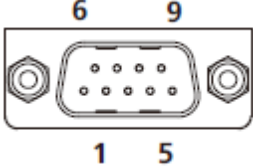
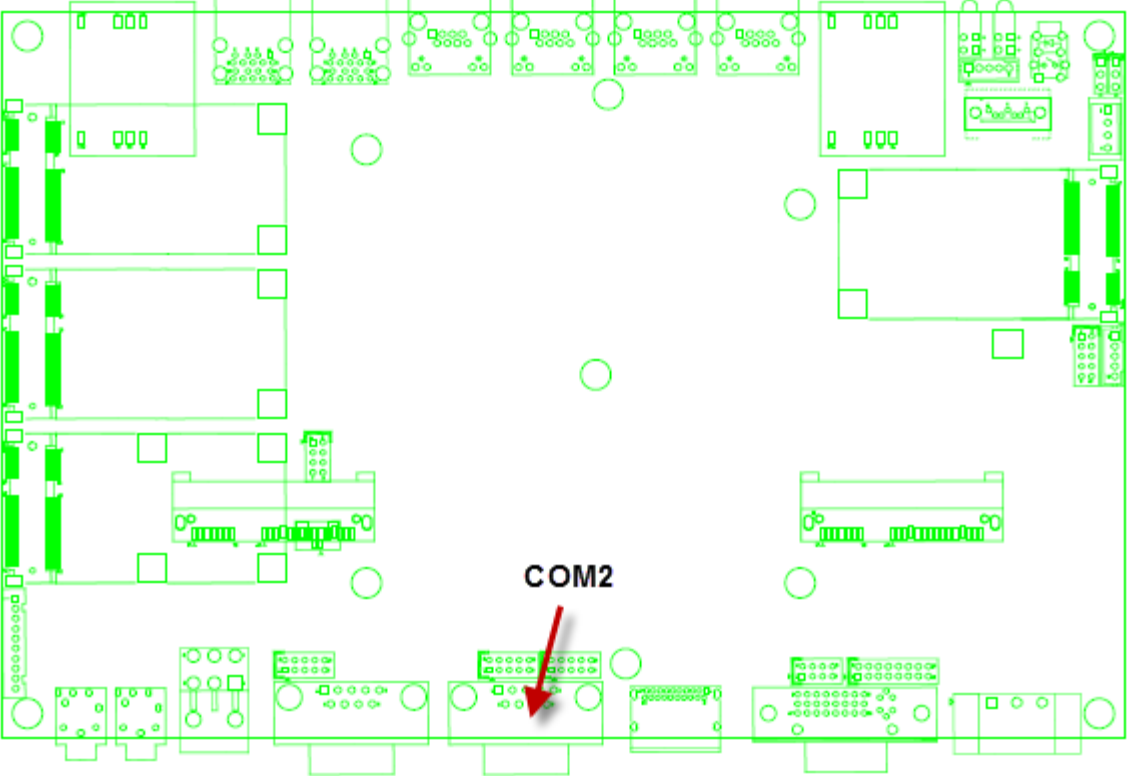
| Connector size | 9 Pin | | | | | | | | | | | | | | | | | | | | | | | | | | | |
|--------------------------|---|-----|---------------------------------------|-----|--------|---|---------------------------------------|---|---------------------------------------|---|----------|---|----------|---|-----|---|----------|---|----------|---|----------|---|----------|--|--|--|--|--|
| Connector type | DSUB | | | | | | | | | | | | | | | | | | | | | | | | | | | |
| Connector location | COM2  | | | | | | | | | | | | | | | | | | | | | | | | | | | |
| Connector pin definition | <table border="1"> <thead> <tr> <th>Pin</th> <th>Signal</th> <th>Pin</th> <th>Signal</th> </tr> </thead> <tbody> <tr> <td>1</td> <td>COM2_DCD <i>(RS-485_TXD-/RXD-)</i></td> <td>2</td> <td>COM2_RXD <i>(RS-485_TXD+/RXD+)</i></td> </tr> <tr> <td>3</td> <td>COM2_TXD</td> <td>4</td> <td>COM2_DTR</td> </tr> <tr> <td>5</td> <td>GND</td> <td>6</td> <td>COM2_DSR</td> </tr> <tr> <td>7</td> <td>COM2_RTS</td> <td>8</td> <td>COM2_CTS</td> </tr> <tr> <td>9</td> <td>COM2_RI#</td> <td></td> <td></td> </tr> </tbody> </table> | Pin | Signal | Pin | Signal | 1 | COM2_DCD <i>(RS-485_TXD-/RXD-)</i> | 2 | COM2_RXD <i>(RS-485_TXD+/RXD+)</i> | 3 | COM2_TXD | 4 | COM2_DTR | 5 | GND | 6 | COM2_DSR | 7 | COM2_RTS | 8 | COM2_CTS | 9 | COM2_RI# | | | | | |
| Pin | Signal | Pin | Signal | | | | | | | | | | | | | | | | | | | | | | | | | |
| 1 | COM2_DCD <i>(RS-485_TXD-/RXD-)</i> | 2 | COM2_RXD <i>(RS-485_TXD+/RXD+)</i> | | | | | | | | | | | | | | | | | | | | | | | | | |
| 3 | COM2_TXD | 4 | COM2_DTR | | | | | | | | | | | | | | | | | | | | | | | | | |
| 5 | GND | 6 | COM2_DSR | | | | | | | | | | | | | | | | | | | | | | | | | |
| 7 | COM2_RTS | 8 | COM2_CTS | | | | | | | | | | | | | | | | | | | | | | | | | |
| 9 | COM2_RI# | | | | | | | | | | | | | | | | | | | | | | | | | | | |
| Connector map |  | | | | | | | | | | | | | | | | | | | | | | | | | | | |

3.11 MIC connector

| | | | | | |
|--------------------------|---|-----------|-----|-----------|--|
| Connector size | 6 Pin | | | | |
| Connector type | Phone Jack | | | | |
| Connector location | MIC1 | | | | |
| Connector pin definition | Pin | Signal | Pin | Signal | |
| | 1 | MIC_OUT-L | 2 | MIC-JD | |
| | 3 | NC | 4 | MIC_OUT-R | |
| | 5 | GND | 6 | GND | |
| Connector map | <p>The image shows a green PCB layout with various components. A red arrow points to a specific connector footprint labeled 'MIC1' located in the lower-left quadrant of the board.</p> | | | | |

3.12 LINE OUT connector

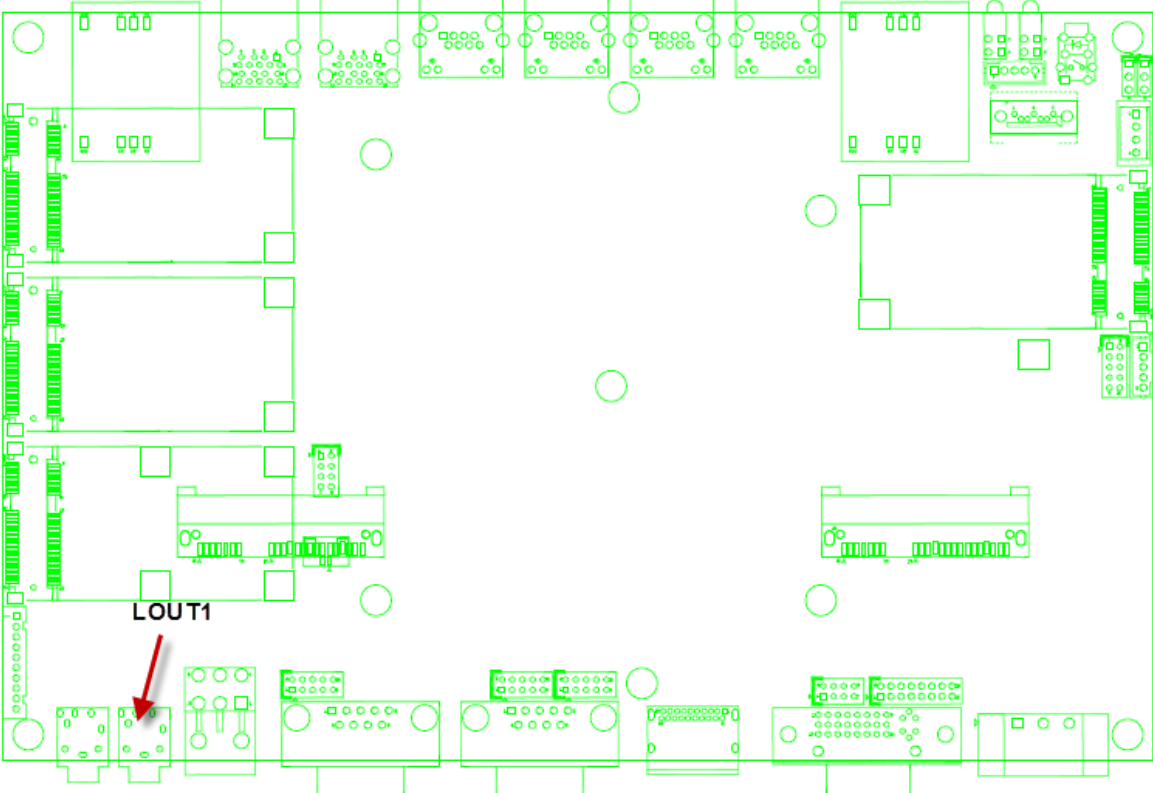
| | | | | | |
|--------------------------|--|-------------|-----|-------------|--|
| Connector size | 6 Pin | | | | |
| Connector type | Phone Jack | | | | |
| Connector location | LOUT1 | | | | |
| Connector pin definition | Pin | Signal | Pin | Signal | |
| | 1 | FRONT_OUT_L | 2 | FRONT-JD | |
| | 3 | NC | 4 | FRONT_OUT_R | |
| | 5 | GND | 6 | GND | |
| Connector map |  <p>The image shows a green PCB layout with various components. A red arrow points to a specific connector footprint labeled 'LOUT1' at the bottom center of the board.</p> | | | | |

3.13 POWER OUT connector

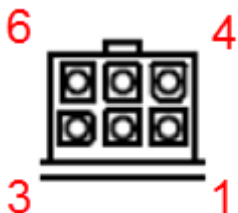
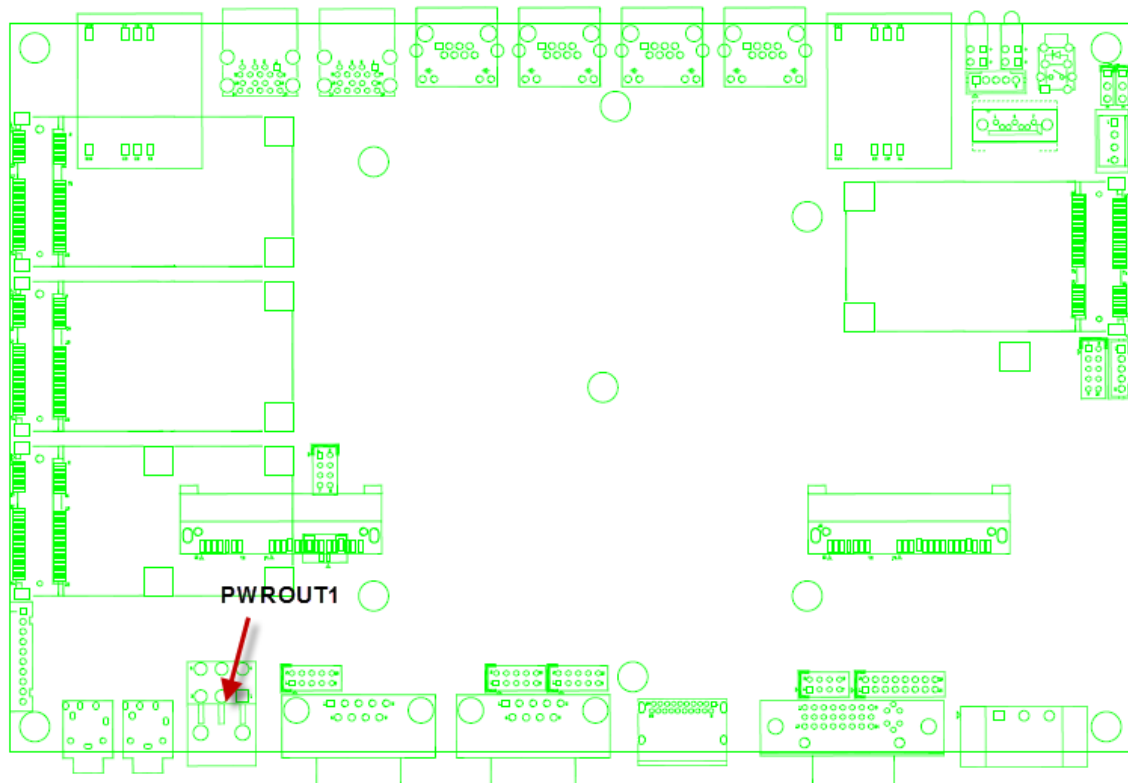
| | | | | | |
|--------------------------|---|---------|-----|---------|--|
| Connector size | 6 Pin | | | | |
| Connector type | ATX 6PIN | | | | |
| Connector location | PWROUT1  | | | | |
| Connector pin definition | Pin | Signal | Pin | Signal | |
| | 1 | +12V | 2 | +12V | |
| | 3 | EXT_DI1 | 4 | GND | |
| | 5 | GND | 6 | EXT_DI2 | |
| Connector map |  | | | | |

4 System Installation

4.1 System Introduction

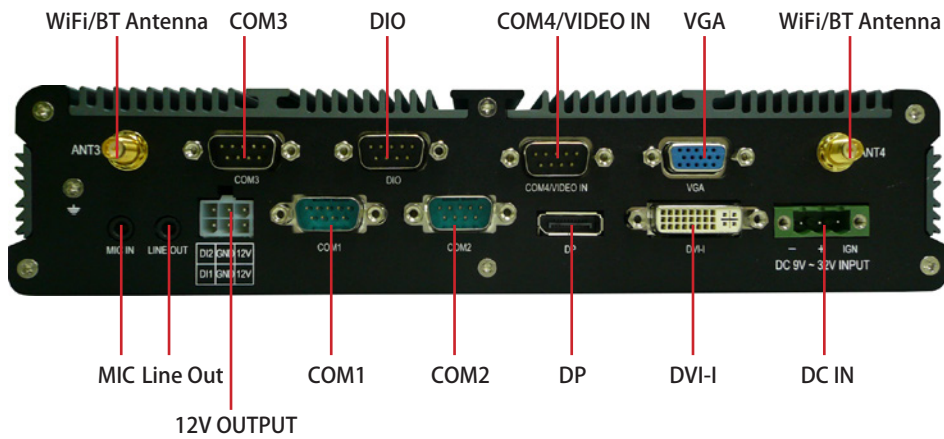
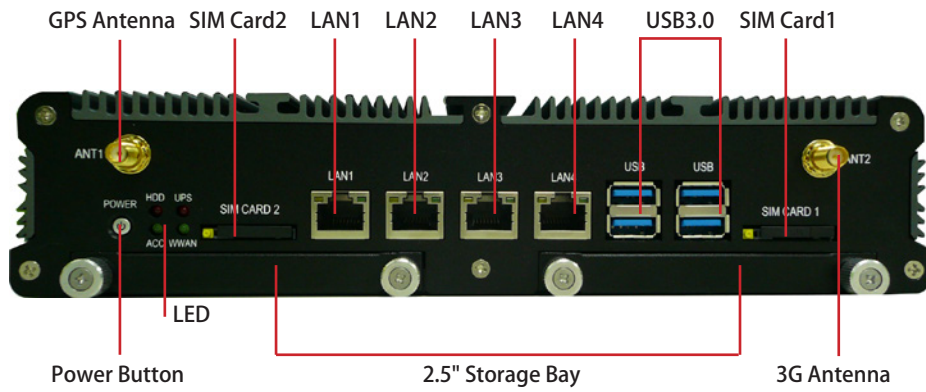

■ 4.2 Opening Chassis

Step 1. Unscrew the six screws of the Back Cover as shown in the picture.



Step 2. Unscrew the six screws of the Front Panel as shown in the picture.



Step 3. Unscrew the six screws of the Rear Panel as shown in the picture.

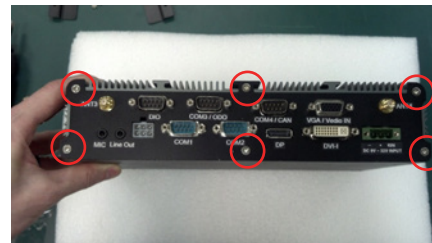

Step 4. Open Top Cover as shown in the picture.



■ 4.3 Installing Memory

Step 1. Put Memory on this place as shown in the picture.

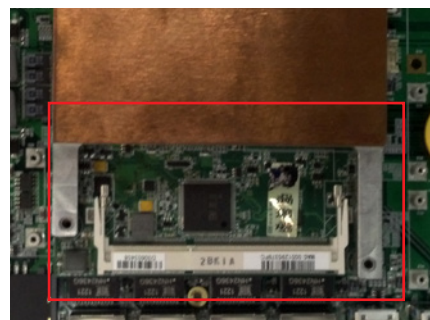

Step 2. Hold the Memory with its notch aligned with the Memory socket of the board and insert it at a 30-degree angle into the socket as shown in the picture.



Step 3. Press down on the Memory so that the tabs of the socket lock on both sides of the module as shown in the picture.

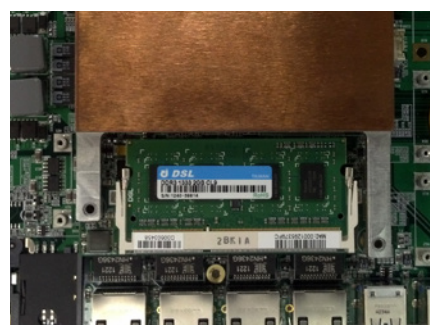

■ 4.4 Installing MINI PCIe Expansion Card (PCIe 1, 3G Module only)

Step 1. Put MINI PCIe Expansion Card on this place as shown in the picture.

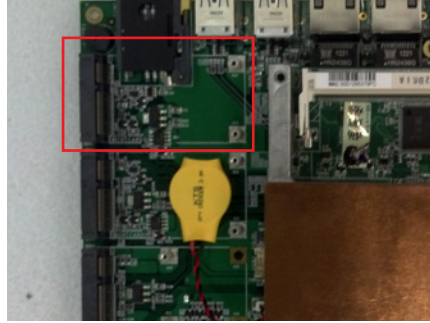

Step 2. Hold the Module with its notch aligned with the socket of the board and insert it at a 30 degree angle into the socket as shown in the picture.



Step 3. Screw two screws to the holder as shown in the picture.



Step 4. Done as shown in the picture.

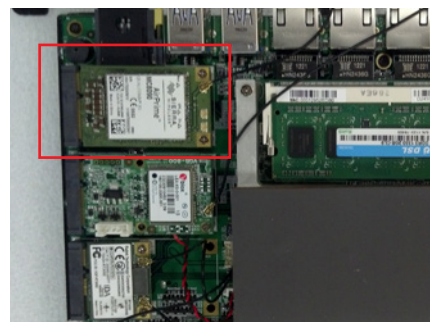

■ 4.5 Installing MINI PCIe Expansion Card (PCIe 2)

Step 1. Put MINI PCIe Expansion Card on this place as shown in the picture.

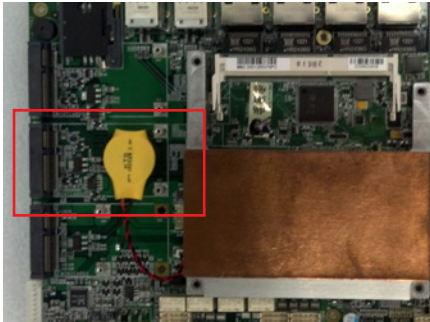

Step 2. Hold the Module with its notch aligned with the socket of the board and insert it at a 30 degree angle into the socket as shown in the picture.



Step 3. Screw two screws to the holder as shown in the picture.



Step 4. Done as shown in the picture.

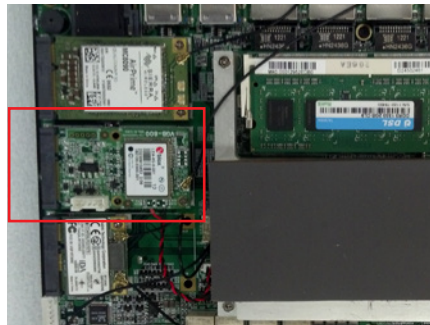

■ 4.6 Installing MINI PCIe Expansion (PCIe 3)

Step 1. Put MINI PCIe Expansion Card on this place as shown in the picture.

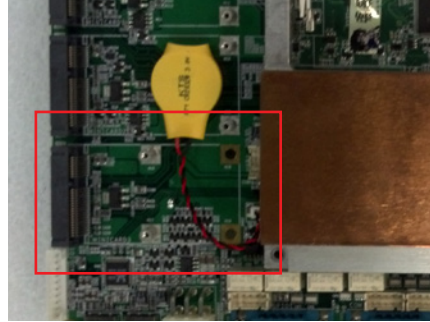

Step 2. Hold the Module with its notch aligned with the socket of the board and insert it at a 30 degree angle into the socket as shown in the picture.



Step 3. Screw two screws to the holder as shown in the picture.



Step 4. Done as shown in the picture.

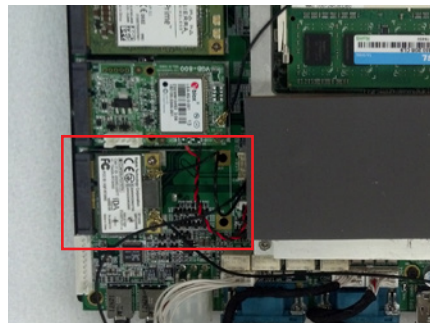

■ 4.7 Installing MINI PCIe Expansion (PCIe 4, PCIe only)

Step 1. Put MINI PCIe Expansion Card on this place as shown in the picture.

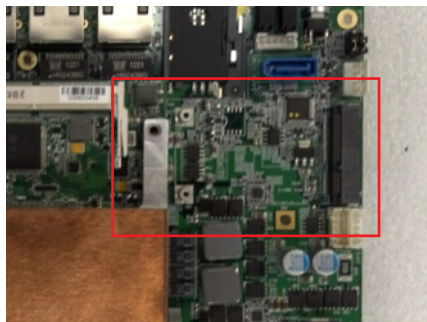

Step 2. Hold the Module with its notch aligned with the socket of the board and insert it at a 30 degree angle into the socket as shown in the picture.



Step 3. Screw two screws to the holder as shown in the picture.



Step 4. Done as shown in the picture.

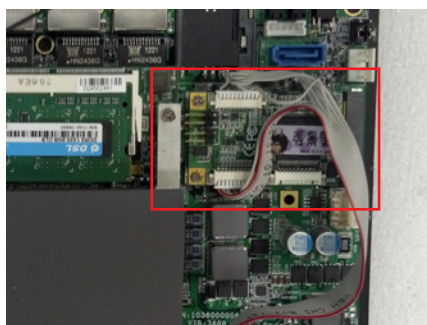

■ 4.8 Installing Internal Antenna Cable

Step 1. Take the SMA Connector and Plug into IO Panel as shown in the picture.

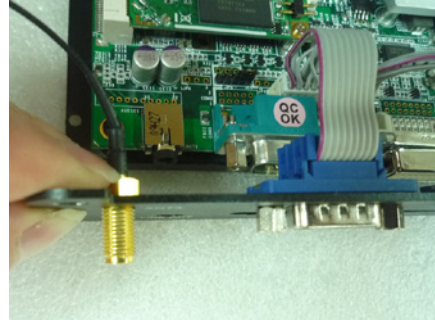

Step 2. Put the Washer into the SMA Connector as shown in the picture.



Step 3. Put the Oring to SMA Connector and tighten as shown in the picture.



Step 4. Done as shown in the picture.



Step 5. Take the Ipex Connector and press on the wifi module as shown in the picture.(Wifi)



Step 6. Take the Ipex Connector and press on the 3G module as shown in the picture. (3G)



Step 7. Take the Ipex Connector and press on the GPS module as shown in the picture. (GPS, only support passive Antenna)



■ 4.9 Installing SIM Card

Step 1. Use thin stick to push the button as shown in the picture.



Step 2. Take the holder away from front panel as shown in the picture.



Step 3. Put your SIM Card into the holder as shown in the picture.



Step 4. Take the SIM card holder and Insert it into the socket as shown in the picture.



4.10 Installing HDD

Step 1. Put the HDD into HDD Holder as shown in the picture.



Step 2. Screw two screws on both side as shown in the picture.

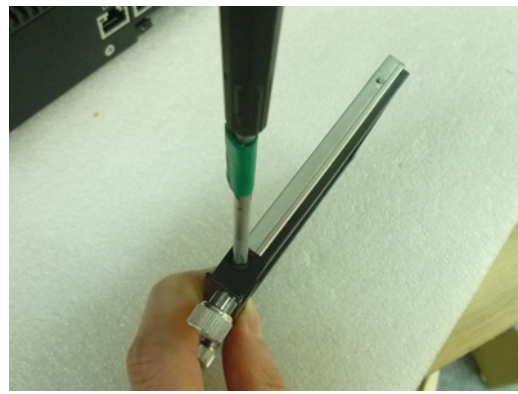

Step 3. Push the HDD Holder into the socket as shown in the picture.



Step 4. Fully insert the HDD Holder into the socket until a “click” is heard as shown in the picture.



Step 5. Tighten to Storage Bracket screws as shown in the picture.



■ 4.11 Installing Battery Module

Step 1. Accessories list



Step 2. Fix the Tube with Screw A on the motherboard

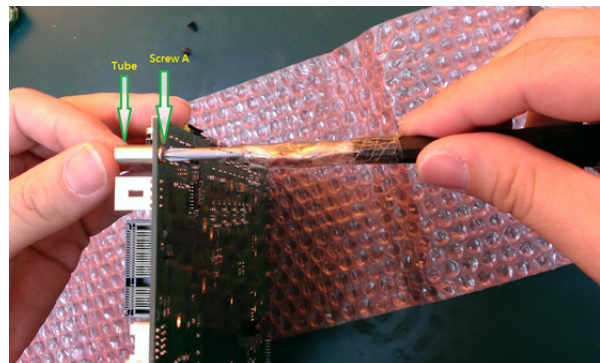

Step 3. Fix the Tube with Screw A to another hole.

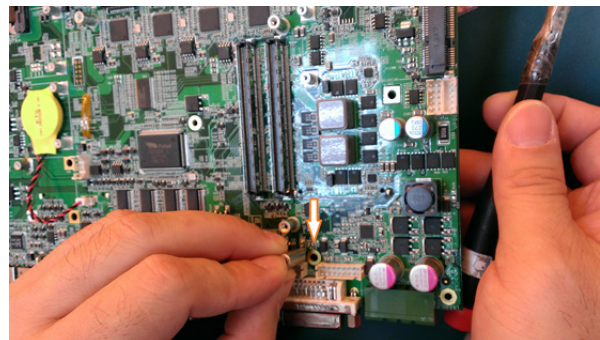

Step 4. Fix the Screw A from back side

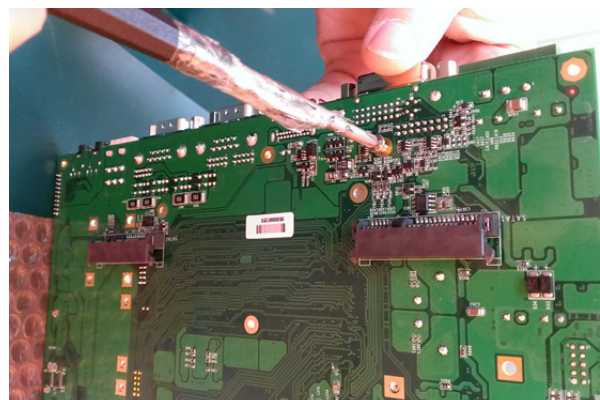

Step 5. Tube Location check.

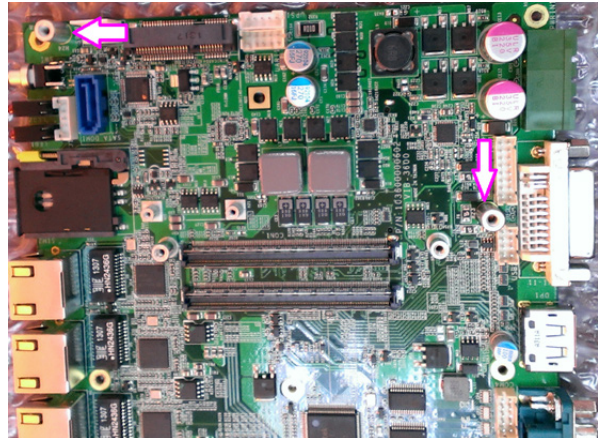

Step 6. Connect the battery with motherboard on UPS location.

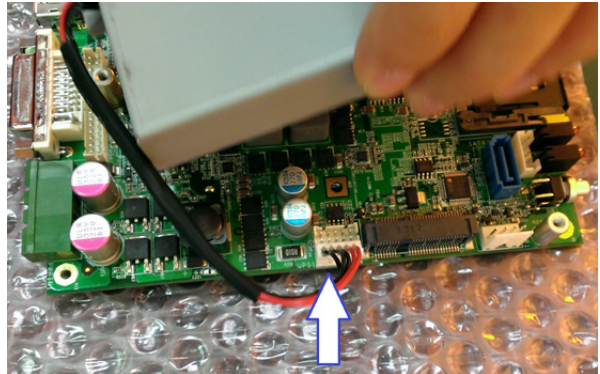

Step 7. Fix the battery with Screw B.
(Done)

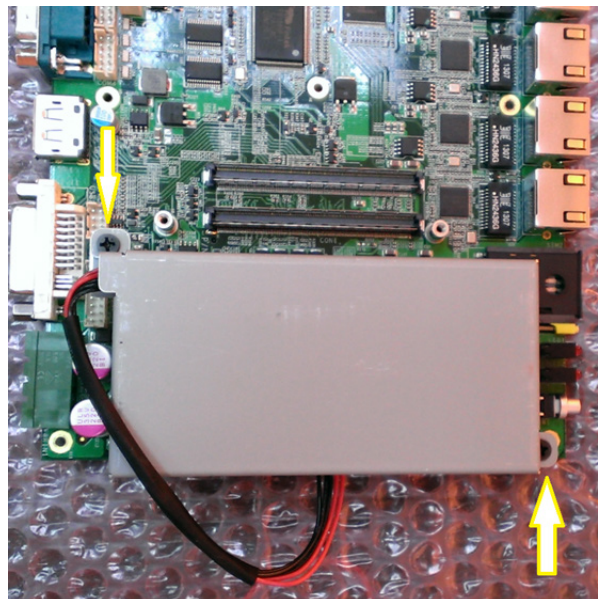

(5) System Resources

5.1 Ignition Power Management Quick Guide

Startup/shutdown conditions from the IGNITION signal:

- IGNITION startup signal must be valid during 3 sec. (anti noise protection).
- IGNITION shutdown – IGNITION signal must be inactive during 3 Sec, then PIC controller initiate Power Button signal (**OS must be set to shutdown from the Power Button**). It generate Main Button shutdown event and then goes to complete power off.

Typically the system can start only from IGNITION signal, because startup PIC controller is disconnected from the power source.

The system can be switched off from:

- Power IGNITION OFF signal.
- ACPI OS shutdown
- Power Button – generate ACPI event (OS dependent).

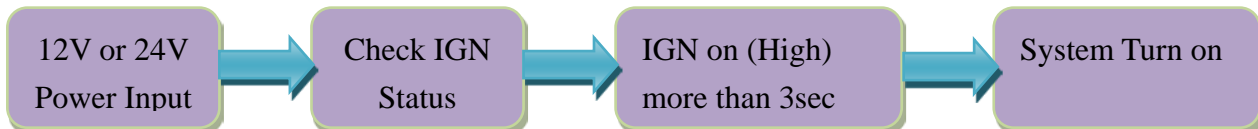

Power Ignition Startup Procedure

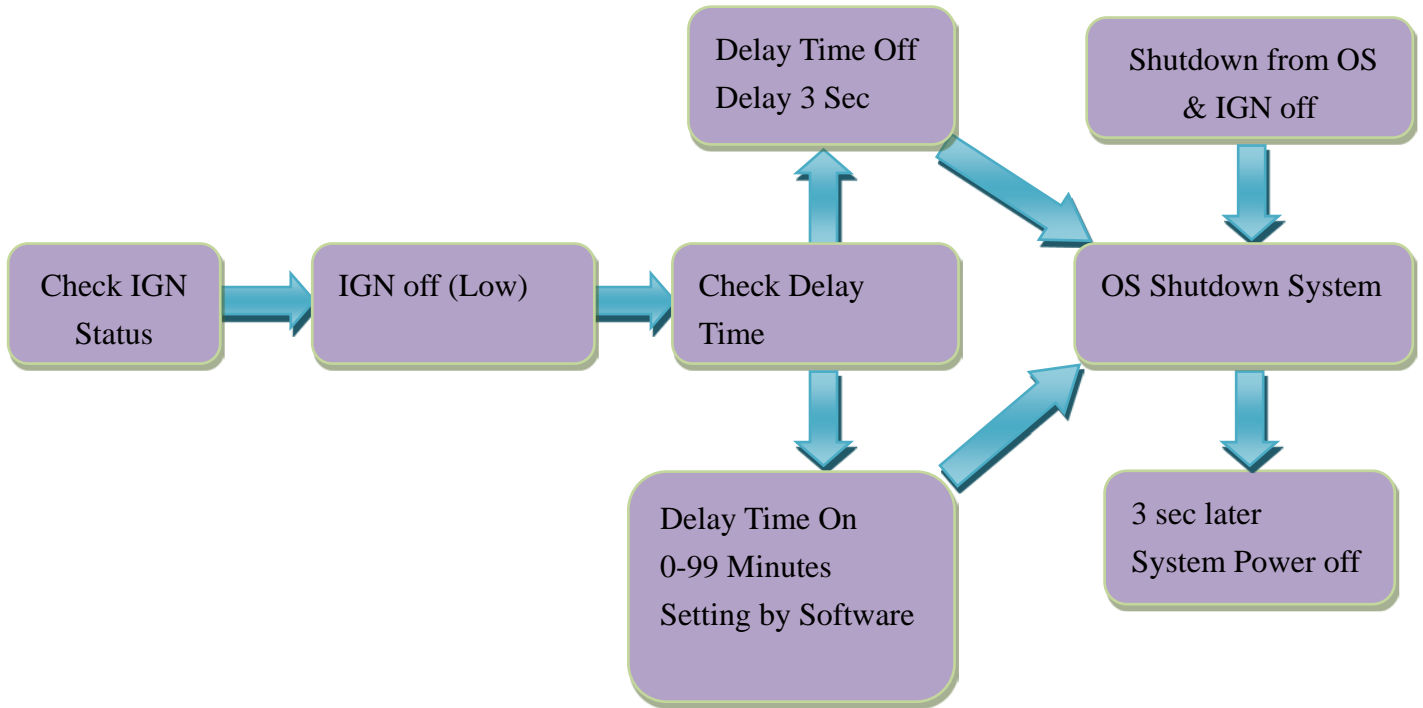

Power Ignition Shutdown Procedure

Power Management

- Power-off delay time is selectable by Software to disable and enable in 0-99 minutes
- Ignition On/Off status detectable by SW
- If the ignition is off and the system is still on after 3 Sec, FleetPC 8 will shut down automatically.
- If the ignition is turned on again and the power-off delay is in progress, FleetPC 8 will cancel the delay function and will continue to operate normally.
- If the ignition is turned on again and the power-off delay ended, FleetPC 8 will shut down completely will power-on again automatically.

5.2 GPIO & Ignition Register

5.2.1 GPIO and Ignition Control Register

The General Purpose I/O is an interface available on some devices. These can read digital signals from other parts of a circuit, or output to control other devices. At GPIO control register, the GPI is use to receive data, the GPO is set data to send.

I/O port: 0xA35 (base address) for Control Register (Read 0xA2h / Write 0xA1h)

0xA36 (base address) for Control Data Value

Debug Command Line

- **O A35 A1**
- **O A36 0F // Set Bit 4-7 to Low**

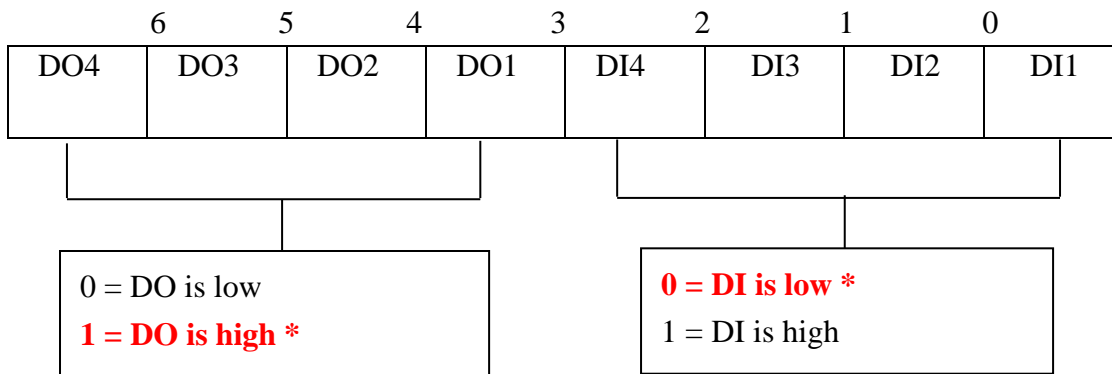

GPIO5 Output Enable Register — Index A0h

| Bit | Name | R/W | Default | Description |
|-----|-----------|-----|---------|---|
| 7 | GPIO57_OE | R/W | 0 | 0: GPIO57 is input. 1: GPIO57 is output. |
| 6 | GPIO56_OE | R/W | 0 | 0: GPIO56 is input. 1: GPIO56 is output. |
| 5 | GPIO55_OE | R/W | 0 | 0: GPIO55 is input. 1: GPIO55 is output. |
| 4 | GPIO54_OE | R/W | 0 | 0: GPIO54 is input. 1: GPIO54 is output. |
| 3 | GPIO53_OE | R/W | 0 | 0: GPIO53 is input. 1: GPIO53 is output. |
| 2 | GPIO52_OE | R/W | 0 | 0: GPIO52 is input. 1: GPIO52 is output. |
| 1 | GPIO51_OE | R/W | 0 | 0: GPIO51 is input. 1: GPIO51 is output. |
| 0 | GPIO50_OE | R/W | 0 | 0: GPIO50 is input. 1: GPIO50 is output. |

GPIO5 Output Data Register — Index A1h

| Bit | Name | R/W | Default | Description |
|-----|-------------|-----|---------|------------------------------------|
| 7 | GPIO57_DATA | R/W | 1 | GPIO57 output data in output mode. |
| 6 | GPIO56_DATA | R/W | 1 | GPIO56 output data in output mode. |
| 5 | GPIO55_DATA | R/W | 1 | GPIO55 output data in output mode. |
| 4 | GPIO54_DATA | R/W | 1 | GPIO54 output data in output mode. |
| 3 | GPIO53_DATA | R/W | 1 | GPIO53 output data in output mode. |
| 2 | GPIO52_DATA | R/W | 1 | GPIO52 output data in output mode. |
| 1 | GPIO51_DATA | R/W | 1 | GPIO51 output data in output mode. |
| 0 | GPIO50_DATA | R/W | 1 | GPIO50 output data in output mode. |

GPIO5 Pin Status Register — Index A2h

| Bit | Name | R/W | Default | Description |
|-----|-----------|-----|---------|--------------------|
| 7 | GPIO57_ST | R | 1 | GPIO57 pin status. |
| 6 | GPIO56_ST | R | 1 | GPIO56 pin status. |
| 5 | GPIO55_ST | R | 1 | GPIO55 pin status. |
| 4 | GPIO54_ST | R | 1 | GPIO54 pin status. |
| 3 | GPIO53_ST | R | 1 | GPIO53 pin status. |
| 2 | GPIO52_ST | R | 1 | GPIO52 pin status. |
| 1 | GPIO51_ST | R | 1 | GPIO51 pin status. |
| 0 | GPIO50_ST | R | 1 | GPIO50 pin status. |

GPIO5 Drive Enable Register — Index A3h

| Bit | Name | R/W | Default | Description |
|-----|---------------|-----|---------|---|
| 7 | GPIO57_DRV_EN | R/W | 0 | GPIO57 Drive Enable. 0: GPIO57 is open drain. 1: GPIO57 is push pull. |
| 6 | GPIO56_DRV_EN | R/W | 0 | GPIO56 Drive Enable. 0: GPIO56 is open drain. 1: GPIO56 is push pull. |
| 5 | GPIO55_DRV_EN | R/w | 0 | GPIO55 Drive Enable. 0: GPIO55 is open drain. 1: GPIO55 is push pull. |
| 4 | GPIO54_DRV_EN | R/W | 0 | GPIO54 Drive Enable. 0: GPIO54 is open drain. 1: GPIO54 is push pull. |
| 3 | GPIO53_DRV_EN | R/W | 0 | GPIO53 Drive Enable. 0: GPIO53 is open drain. 1: GPIO53 is push pull. |
| 2 | GPIO52_DRV_EN | R/W | 0 | GPIO52 Drive Enable. 0: GPIO52 is open drain. 1: GPIO52 is push pull. |
| 1 | GPIO51_DRV_EN | R/W | 0 | GPIO51 Drive Enable. 0: GPIO51 is open drain. 1: GPIO51 is push pull. |
| 0 | GPIO50_DRV_EN | R/W | 0 | GPIO50 Drive Enable. 0: GPIO50 is open drain. 1: GPIO50 is push pull. |

I/O port: I/O port: **0xA35 (base address)** for Control Register (Read 0xF2h bit 3)
0xA36 (base address) for Control Data Value

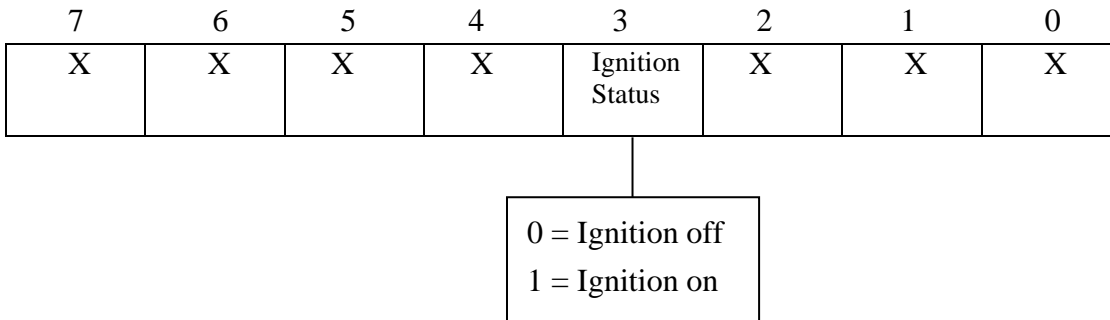

Debug Command Line

- O A35 F2
- I A36 // Check Bit 3 Status

5.2.2 WDT Setting

I/O port: A10 (base address) + 05h and 06h
1 Watchdog Timer Control Register

The Watchdog Timer Control Register controls the WDT working mode. Write the value to the WDT Configuration Port. The following table describes the Control Register bit definition:

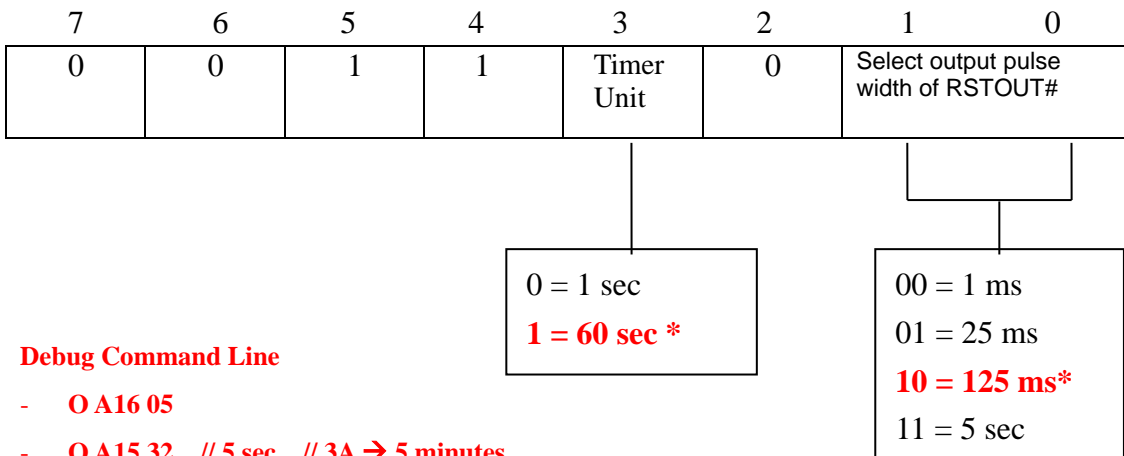

Debug Command Line

- O A16 05
- O A15 32 // 5 sec // 3A → 5 minutes

7.9. Watchdog Timer Function

Watch dog timer is provided for system controlling. If time-out can trigger one signal to high/low level/pulse, the signal is depend on register setting.

The time unit has two ways from 1sec or 60sec. In pulse mode, there are four pulse widths can be selected (1ms/25ms/125ms/5sec). Others, please refer the device register description as below.

Watchdog Timer Configuration Register 1— base address + 05h

| Bit | Name | R/W | Default | Description |
|-----|-------------|-----|---------|--|
| 7 | Reserved | R | 0 | Reserved |
| 6 | WDTMOUT_STS | R/W | 0 | If watchdog timeout event occurs, this bit will be set to 1. Write a 1 to this bit will clear it to 0. |

| | | | | |
|-----|------------|-----|---|--|
| 5 | WD_EN | R/W | 0 | If this bit is set to 1, the counting of watchdog time is enabled. |
| 4 | WD_PULSE | R/W | 0 | Select output mode (0: level, 1: pulse) of RSTOUT# by setting this bit. |
| 3 | WD_UNIT | R/W | 0 | Select time unit (0: 1sec, 1: 60 sec) of watchdog timer by setting this bit. |
| 2 | WD_HACTIVE | R/W | 0 | Select output polarity of RSTOUT# (1: high active, 0: low active) by setting this bit. |
| 1-0 | WD_PSWIDTH | R/W | 0 | Select output pulse width of RSTOUT# 0: 1 ms 1: 25 ms 2: 125 ms 3: 5 sec |

Watchdog Timer Configuration Register 2 — base address + 06h

| Bit | Name | R/W | Default | Description |
|-----|---------|-----|---------|------------------------|
| 7-0 | WD_TIME | R/W | 0 | Time of watchdog timer |

Watchdog PME Control Register — base address + 0Ah

| Bit | Name | R/W | Default | Description |
|-----|------------|-----|---------|---|
| 7 | WDT_PME | R | -- | The PME Status. This bit will set when WDT_PME_EN is set and the watchdog timer is 1 unit before time out (or time out). |
| 6 | WDT_PME_EN | R/W | 0 | 0: Disable Watchdog PME. 1: enable Watchdog PME. |
| 5-1 | Reserved | -- | -- | Reserved. |
| 0 | WDOUT_EN | R/W | 0 | 0: disable Watchdog time out output via WDTRST#. 1: enable Watchdog time out output via WDTRST#. |

(6) BIOS

6.1 Super IO Configuration

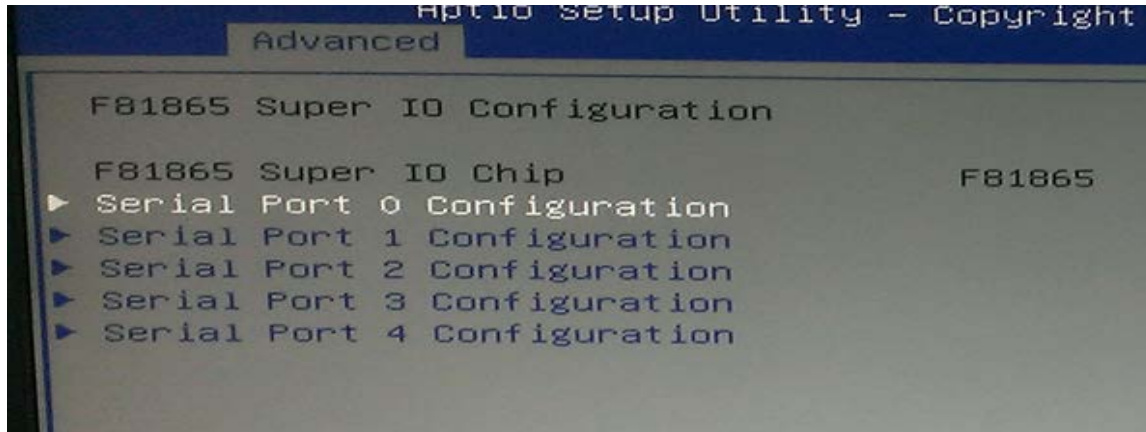

Select Serial Port Mode



(7) Packing List

7.1 Packing List

| Item | Part Number | Module Name |
|------|--------------|-------------------------------|
| 1 | 763600000100 | FleetPC 8 System |
| 2 | 370832001100 | FleetPC 8 Mount Bracket |
| 3 | 351103040250 | Screw F Type M3*4L ISO BK |
| 4 | 326710039661 | CABLING PHOENIX CON MALE 3PIN |

Optional

| Part No. | Vendor / Model | Description |
|--------------|-----------------------------|---|
| 577710140090 | MC7710 | LTE – DD 800MHz (Band 20) / 900MHz (Band 8) /2600MHz (Band 7) / 1800MHz (Band 3) / 2100MHz (Band 11) MHz DC-HSPA+1/HSPA+/HSUPA/HSDPA/UMTS – 900/2100MHz Quad-band EDGE/GPRS/GSM – 850/900/1800/1900MHz GPS is Standalone, gpsOne XTRA assistance for enhanced standalone GPS performance, MS-based assisted (support varies based on network carrier) (3G or 4G Antenna Kit be included) |
| 573000011092 | Gobi3000-Dual (MC8355) | HSDPA/UMTS –800/850/900/1900/2100MHz Quad-band EDGE/GPRS/GSM –850/900/1800/1900MHz Dual-band EV-DO/CDMA –800/1900MHz GPS is Standalone, gpsOne XTRA assistance for enhanced standalone GPS performance, MS-based assisted (support varies based on network carrier) (3G Antenna Kit be included) |
| 573000120009 | Gobi3000-Single (MC8305) | HSDPA/UMTS –850/900/1800/1900/2100MHz Quad-band EDGE/GPRS/GSM –850/900/1800/1900MHz Single-band CDMA –1900MHz GPS is Standalone, gpsOne XTRA assistance for enhanced standalone GPS performance, MS-based assisted (3G Antenna Kit be included) |
| 578090120091 | (MC8090) | HSDPA/UMTS –850/900/1900/2100MHz Quad-band EDGE/GPRS/GSM –850/900/1800/1900MHz Single-band CDMA –1900MHz GPS is Standalone, gpsOne XTRA assistance for enhanced standalone GPS performance, MS-based assisted Supports Voice function (3G Antenna Kit be included) |

| | | |
|--------------|-----------|---|
| 570800100109 | VDB-800S | <p>Embedded u-blox6 GPS Mini PCIe Card Very high sensitivity (Tracking Sensitivity: -160 dBm) 50 Channels / Hot Start 1s / Warm Start 28s / Cold Start 28s AssistNow Online and Offline A-GPS Services,OMA SUPL Compliant Support NMEA 0183 V3.0 Update Rate 5 Hz (Max.) (GPS Active Antenna be included)</p> |
| 570800100101 | VDB-800DR | <p>Embedded u-blox6 GPS with Dead Reckoning and G-sensor Mini PCIe Card Very high sensitivity (Tracking Sensitivity: -160 dBm) 50 Channels / Hot Start 1s / Warm Start 40s / Cold Start 45s Support NMEA 0183 V3.0 AssistNow Online and Offline A-GPS Services,OMA SUPL Compliant 100% Coverage with Continuous Position Fixes Even in Tunnels Highly Accurate and Reliable Navigation Performance Automatic Sensor Calibration and Temperature Include odometer cable. (GPS Active Antenna be included)</p> |
| 570800160009 | VDB-800SG | <p>Embedded u-blox6 GPS Mini PCIe Card and G-sensor Very high sensitivity (Tracking Sensitivity: -160 dBm) 50 Channels / Hot Start 1s / Warm Start 28s / Cold Start 28s AssistNow Online and Offline A-GPS Services,OMA SUPL Compliant Support NMEA 0183 V3.0 Update Rate 5 Hz (Max.) (GPS Active Antenna be included)</p> |
| 346123002001 | VDB-801 | <ul style="list-style-type: none"> •50-channel u-blox6 Engine with Over 2 Million Effective Correlators •-146dBm SuperSense® Acquisition and Tracking Sensitivity •AssistNow Online and Offline A-GPS Services,OMA SUPL Compliant •100% Coverage with Continuous Position Fixes Even in Tunnels •Highly Accurate and Reliable Navigation Performance •Automatic Sensor Calibration and Temperature •Operating Temperature : -40°C to 80°C |
| 570802090009 | Q802XKN3B | <p>Ralink(RT3090BC4) 1X1 802.11n, Wireless Lan and CSR Bluecore4 Bluetooth2.1+EDR (Microsoft in-box driver, profiles;Motorola profiles) / software upgradable to BT3.0+HS(Motorola) Combo Mini-PCIe Card (Wifi Antenna Kit be included)</p> |

| | | |
|--------------|----------------|---|
| 570195090090 | DHXA-195 | 802.11n b/g 1x1 wifi plus Bluetooth combo PCIe half-size mini card, WB195/AR9285+AR3011 (Wifi Antenna Kit be included) |
| 570802010009 | Q802XKN5F | Ralink 802.11b/g/N, 2T2R,Mini PCIe Card (Full size) (Wifi Antenna Kit be included) |
| 570802011009 | Q802XKN5 | Ralink 802.11b/g/N, 2T2R,Mini PCIe Card (Half size)(Wifi Antenna Kit be included) |
| 571350010090 | DNXA-116 | 802.11 a/b/g/n, Atheros AR9382, 2T2R, Half-size Mini-PCle card (Wifi Antenna Kit be included) |
| 345570033000 | 7-in-1-1dBi-5M | GPS+3G+WIFI Combo Antenna SMA Male, 7-in-1 Multi-band / 5M |
| 342631091000 | WiFi-2dB | Wifi Antenna 2dBi / 2.4G / SMA Female (silver color) |
| 342631391031 | WiFi-5dB-3M | Wifi Antenna 5dBi / 2.4G / 3M / SMA Male (Flat Type) |
| 343131091000 | 3G-2dBi | 3G Antenna 2dBi / 3.5G / GPRS / SMA Female (gold color) |
| 344220033000 | 3G-1.5dBi-3M | 3G Antenna 1.5dBi / 3.5G / GPRS / 3M / SMA Female (Flat Type) |

| | | |
|---------------------|-----------------------|---|
| 343225003000 | GPS-Passive-5M | GPS Passive Antenna 5M / SMA male (Only for GOBI Series) |
| 343235002000 | GPS-Active-5M | GPS Active Antenna 5M / SMA male |
| 221401280006 | BAT-3600 | Neosonic-Polymer 1100mAH 3S1P Battery kit for FleetPC 8 |
| 972009720000 | Microsoft | Windows Embedded Standard 2009 (Windows XP Embedded) |
| 970000750000 | Microsoft | Windows XP Pro license fee |
| 970007740000 | Microsoft | Windows® Embedded Standard 7 Runtime (WS7E)(ESD) |
| 970022730000 | Microsoft | Windows® 7 Professional for Embedded Systems x32/x64 |